



Euro Games Technology (EGT)

Founded in 2002 and headquartered in Sofia, Bulgaria, Euro Games Technology (EGT) began establishing its reputation in the highly competitive casino industry. A firm belief of the company since its creation is that the only path to success is to give more to the customers, exceeding their expectations and surpassing other suppliers' product developments.

Following these business principles, EGT achieved worldwide recognition for its high-standard portfolio, preferred by casino operators and players for its impeccable quality, outstanding design, and top-notch technology.

Nowadays, the company's product range includes a variety of video slot cabinets and games, jackpot systems, multiplayer solutions, VLT, server-based and casino management systems, and diverse gaming equipment accessories.

EGT machines are installed in over 100 countries throughout Europe, America (South, Central, and North), Africa, and Asia. International certificates obtained from various regulatory agencies and testing laboratories are evidence of the strict compliance of all gaming machines of the company with the technical and legislative requirements of many jurisdictions worldwide. In pursuit of the utmost quality, EGT is also constantly optimizing its technological environment and internal processes. As a result, the company successfully implemented the SAP ERP integrated solution for business management and has been certified in the quality management system ISO 9001:2015.

EGT's technical achievements and key product novelties are presented each year at the most prestigious local and international gaming industry exhibitions. Visit our website and find more information in the Events section.

Euro Games Technology has been recognized as one of the fastest-growing companies in the gaming industry. Within the last several years of its production, research & development activities, warehouse, and administration have developed significantly and are currently housed in 12 buildings in Bulgaria, spread across around 51,448 square meters. EGT's distribution network consists of 28 foreign offices and dealers in different global regions.

Come and visit us. We would love to show you around.



Vladimir Dokov
Chief Executive Officer

Dear customers and friends,

We start every year full of new ideas, passion, and desire for development, allowing us to put our dedication, progressive thinking, and technological breakthroughs to use in the never-ending journey toward gaming excellence.

Today I am proud to present to you the next chapter of our story – the latest edition of our product catalogue.

Meticulously organized, our numerous products showcase the result of extensive research on the needs of our clients, the latest technological advancements, and players' preferences. Combining creativity, team effort, and extensive experience, we have crafted products that exceed your expectations.

The General Series cabinets have become a benchmark for slot machines, bringing the latest innovations to your doorstep. Each unit is created and designed to fulfill a different need, creating the possibility to customize the gaming experience of your players to the last detail. The models' various curved displays are only part of their advantages that will undoubtedly raise your players' satisfaction.

We continue to consolidate our global positions by creating new single games targeting the markets of North and Latin America. A combination of unique multigame mixes and signature jackpot systems are all a part of our portfolio, creating a vast array of titles with different themes, real-life graphics, and high-performing math models.

In the catalogue, you will learn more about the new additions to the VLT and Spider systems that make them an even more intricate part of our vast portfolio. The Spider CMS offers full control of all casino operations with the push of a button, making it an invaluable asset for casino management.

Thank you for taking the time and getting acquainted with our latest product developments. I sincerely hope that, among them, you will find the best match for your gaming establishment and that they will bring you the satisfaction of having many new, excited, and loyal players.

CONTENTS

GAMES

Jackpot Systems	8
Cabinets	52
Phoenix Cabinet	75
Electronic Table Games.....	78

MULTIGAMES

Supreme Multigames.....	98
General Multigames	108
Power Multigames	122
Gold Collection HD	126

ACCESSORIES

General Accessories	130
---------------------------	-----

Global Solution VLT System

Global Solution VLT System	150
VLT Multigames	154

AWP

AWP Cabinets.....	168
AWP Markets.....	176

Spider CMS

Spider CMS	206
------------------	-----

CONTACTS

Contacts	218
----------------	-----

The image features a solid red background with white abstract line art. The lines form a large, stylized letter 'G' that is composed of multiple parallel lines, creating a sense of depth and movement. The lines are arranged in a way that they seem to flow from the top left towards the bottom right, with some lines curving and overlapping to form the shape of the letter 'G'.

GAMES

Discover the fresh interface of the new Bell Link Boost jackpot, where an array of six thrilling games can transform every moment into a chance to win big. Be on the lookout for the Boost feature that will amplify the amount of the Major and Grand jackpots, fulfilling your gaming wishes. Get ready to elevate your gaming experience to new heights with Bell Link Boost.

AVAILABLE CABINETS

The jackpot is compatible with all cabinets of the series GENERAL, PREMIER, S 32-32 UP & S 32-32 ST.

AVAILABLE GAMES

Super Power

Burning Power

Cleopatra's Legacy

More Super Power

More Burning Power

Pharaoh's Heritage

AVAILABLE PANELS

Each jackpot is compatible with any panel.

Premium Progressive Controller (PPC)	Bell Link Boost
Jackpot	Multi-level progressive jackpot
Gaming Platform	EXCITER IV
SAS Protocol	SAS 6.03

BELL Link Boost new



Gods & Kings has 4 exciting levels, of which the Grand and Major are progressive and common for all games and bets, while the Minor and Mini levels are fixed and change their values. There are also a variety of bonus games that will immerse you into a magical world where you'll get a chance to get in touch with the mysterious divine characters.

AVAILABLE GAMES



AVAILABLE CABINETS

The jackpot is compatible with all cabinets of the series GENERAL, PREMIER, S 32-32 UP & S 32-32 ST.

AVAILABLE PANELS

Each jackpot is compatible with any panel.

Premium Progressive Controller (PPC)	Gods & Kings Link
Jackpot	Multi-level progressive jackpot
Gaming Platform	EXCITER IV [®]
SAS Protocol	SAS 6.03

GODS & KINGS LINK



RISE OF RA



GODS
KINGS
LINK

Set off on a thrilling quest with Rise of Ra, a cherished favorite and a pivotal component of the Gods & Kings Link jackpot.

Venture into the unknown, where the appearance of 3 or more Scatter symbols unlocks the gateway to 15 Free Spins, each adorned with an x3 Multiplier. But the adventure continues with the prospect of retriggering and potentially unveiling an additional 15 Free Spins to extend your journey.

After the final Free Spin, players stand at the precipice of a Feature Chance if the Jackpot Feature hasn't been triggered during the Free Spins, adding an extra layer of excitement to your quest for riches. May the gods favor you as you strive for monumental triumphs!

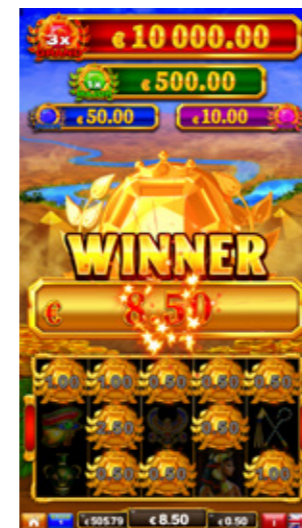
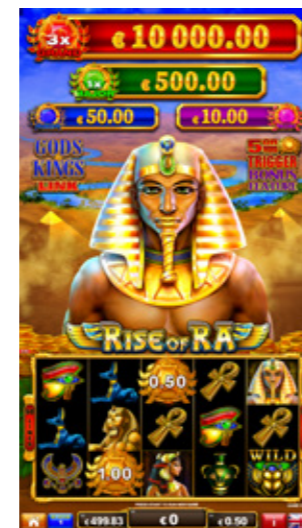

Embark on an epic odyssey to the summit of the Gods with Olympus Glory.

Discover the enchantment when 3 or more WILD symbols grace the reels, triggering a cascade of 10 Free Spins with the potential to secure an additional 10 Free Spins.

But, behold, as the last Free Spin concludes, players stand at the threshold of a Feature Chance. Should the Jackpot Feature remain elusive during the Free Spins, this play awaits.

Just remember, the Jackpot Feature can't be triggered during the Free Spins but can be triggered during the Feature Chance, adding an extra layer of suspense to your celestial escapade. May the Gods smile upon you as you navigate the reels in pursuit of glory!

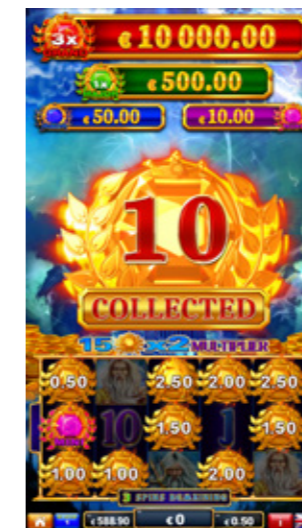

OLYMPUS GLORY



GODS
KINGS
LINK

APE OF LUCK



**GODS
KINGS
LINK**

Immerse yourself in a thrilling jungle adventure with Ape of Luck. When 3, 4, or 5 Scatter symbols come alive, they open the door to an exciting Coin Feature. In it, players may randomly unlock either 8 Free Spins with a growing Multiplier or the coveted Gods & Kings Link Jackpot Feature.

As the Free Spins unfolds, witness the reels undergo a mesmerizing transformation into a vibrant array of Scatter, +1 Free Spin, and empty symbols. The ultimate triumph is determined by the count of Scatter symbols, with the potential to reach an astonishing x1000 of the total game bet.

Will you be the bold explorer destined to unveil the secrets hidden within? The jungle beckons and fortune favors the daring.

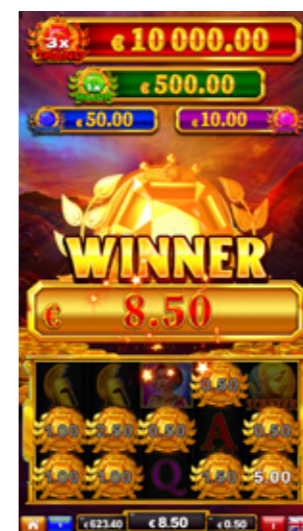
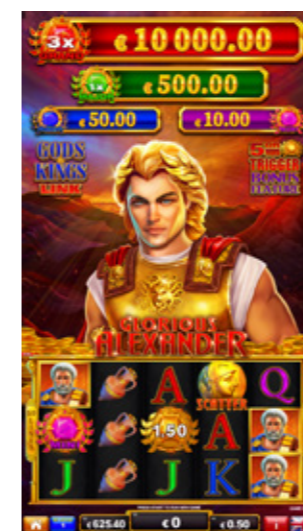
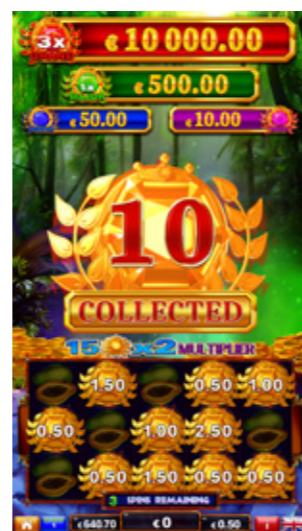
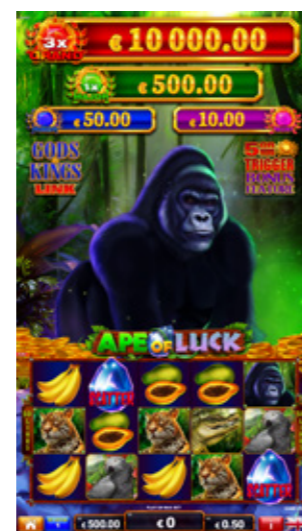

Journey into the realm of Glorious Alexander, one of the greatest conquerors in history. Unveil the mysteries when 3, 4, or 5 Scatter symbols grace the reels, unlocking 10, 15, or 20 Free Spins. Behold the strategic brilliance of Alexander as his symbol leaves a mark during Free Spins, capturing positions with its distinctive Special Frame.

As the final Free Spin unfolds, witness the enchantment – every Special Frame transforms into a Wild symbol, showering players with a cascade of triumphant rewards.

Following the culmination of the last Free Spin, a Feature Chance emerges, offering a lifeline to those whose pursuit of the Jackpot Feature remains unfulfilled during the initial Free Spins saga. Will you seize this opportunity to etch your name into the chronicles of glory?

GLORIOUS ALEXANDER



**GODS
KINGS
LINK**

Bell Link has 4 exciting levels, of which the Grand and Major are progressive and common for all games and bets (Linked, Progressive), while the Minor and Mini levels are fixed and change their values according to different denominations. Minor and Mini jackpot bells are purple and blue and can be won multiple times during the Bell Link bonus; the Grand and Major levels can be attained that way too, as well as with any bet that brings a green bell or a trio of festive red bells that signal the win of the highest Grand.

AVAILABLE CABINETS

The jackpot is compatible with all cabinets of the series GENERAL, PREMIER, S 32-32 UP & S 32-32 ST.



AVAILABLE MULTIGAMES



20 Super Hot	Flaming Hot
40 Super Hot	Flaming Hot Extreme
Burning Hot	Shining Crown
40 Burning Hot	40 Shining Crown
5 Dazzling Hot	Vampire Night

40 Lucky King Extreme	40 Super Hot
Zodiac Wheel Xtra	40 Burning Hot
Book of Realm	Shining Crown
Egypt Sky	40 Shining Crown
Mystic Desert	Vampire Night

Premium Progressive Controller (PPC)	Bell Link
Jackpot	Multi-level progressive jackpot
Gaming Platform	EXCITER III EXCITER IV
SAS Protocol	SAS 6.03





BELL Link

The Bell Link bonus is a thrill ride for every player, that triggers when 5 or more bells appear on the screen and gives away 3 free spins; from then on every bell you collect resets your free spin counter, giving away credits and activating multipliers or jackpot levels.

Another special bell is the Reels Boost that can unleash a mode of 20 reel positions for a richer, longer gaming experience.

Ready to ring the Bell?



AVAILABLE PANELS
Each jackpot is compatible with any panel.

Zhao Cai Shuang Yu is the latest multi-level progressive jackpot for the Exciter IV platform! Featuring two progressive levels (Grand and Major) and two non-progressive levels (Minor and Mini), this jackpot integrates with games like Rising Coins and Prosperity Strike. In Rising Coins, the KEEP & SPIN bonus activates with 1 to 5 special symbols, while Prosperity Strike triggers the FREE SPINS & WHEEL feature with 1 to 3 special symbols.

To win a respective jackpot level, players must collect three special symbols during the bonus game. With this new system, they have the chance to win at any bet level, with higher stakes increasing the likelihood of hitting the Grand Jackpot. This dynamic jackpot system enhances the gaming experience and is set to be a standout addition to any casino floor.

AVAILABLE GAMES



AVAILABLE CABINETS

G 55 C VIP	G 50 J1 UP	G 50 C ST
G 55 J1 VIP	G 50 J2 ST	G 50 C UP
G 50 J1 ST	G 50 J2 UP	G 50 V ST
S 32-32 UP		S 32-32 ST

AVAILABLE PANELS

Each jackpot is compatible with any panel.

Premium Progressive Controller (PPC)	Zhao Cai Shuang Yu
Jackpot	Multi-level progressive jackpot
Gaming Platform	EXCITER IV
SAS Protocol	SAS 6.03 PPJS



Enjoy the unlimited growth of Sheng Sheng Bu Xi, an exhilarating experience with special symbols that trigger unique bonus features. Keep an eye out for the different colored symbols, as they hold the power to unleash a jackpot combo, adding an extra layer of adventure to your gameplay. Join us in a world where the possibilities for fortune are infinite.

AVAILABLE GAMES



AVAILABLE CABINETS

G 55 C VIP	G 50 J1 UP	G 50 C ST
G 55 J1 VIP	G 50 J2 ST	G 50 C UP
G 50 J1 ST	G 50 J2 UP	G 50 V ST
S 32-32 UP		S 32-32 ST

AVAILABLE PANELS

Each jackpot is compatible with any panel.

Premium Progressive Controller (PPC)	Sheng Sheng Bu Xi
Jackpot	Multi-level progressive jackpot
Gaming Platform	EXCITER IV
SAS Protocol	SAS 6.03



Supreme Combo Link has 4 exciting levels – Grand and Major are progressive, while Minor and Mini are Bonus Prize and Non-progressive.

The scarabs lead the way to wealth, starting with the Green Scarab, which grants players 8 Free Spins. In them, frames may appear around the figures, and they remain until the end of the Free Spins. As a finishing touch, one Super Spin is played, and winnings are paid only for the figures in the frames. If the frames fill out the whole screen, there is a special multiplier.

The Blue Scarab offers a Keep&Spin bonus with up to three resets when Scarabs with credit are spinning on the screen. A full screen of Blue Scarabs grants a win multiplier.

And now for the cherry on top – the Red Scarab, which starts a Jackpot Pick-up bonus with 12 elements, where opening three of the same elements, wins the corresponding jackpot level.

Another four types of bonuses await as a mix of the previous three, and if the jackpot is opened with another bonus, up to three extra coins with winnings from previous bonuses can be won.

AVAILABLE GAMES



AVAILABLE CABINETS

G 55 C VIP	G 50 J1 UP	G 50 C ST
G 55 J1 VIP	G 50 J2 ST	G 50 C UP
G 50 J1 ST	G 50 J2 UP	G 50 V ST
S 32-32 UP		S 32-32 ST

AVAILABLE PANELS

Each jackpot is compatible with any panel.

Premium Progressive Controller (PPC)	Supreme Combo Link
Jackpot	Multi-level progressive jackpot
Gaming Platform	EXCITER IV
SAS Protocol	SAS 6.03

SUPREME COMBO LINK



EGYPT REIGN



SUPREME COMBO LINK

Egypt Reign and Princess of Wealth unite in the Supreme Combo Link jackpot, featuring vibrant scarabs that combine for four distinct bonus types.

The Green and Red Scarab pairing delights players with 8 Free Spins, during which frames may encase symbols, transforming them and accumulating wins by the end of the Free Spins. Subsequently, the Red Scarab credits merge, triggering a Pick-up Jackpot Bonus with 15 elements.

The Blue and Red Scarab duo introduces a Keep&Spin bonus comprising three spins, resettable by new symbols. Following this, the Red Scarab credits combine, initiating a Pick-up Jackpot Bonus with 15 elements.

The Blue and Green Scarab alliance unveils the familiar Keep&Spin bonus, where framed figures transform into symbols, accumulating wins. Completing the entire screen brings forth a special multiplier.

The Red, Blue, and Green Scarabs synchronize to activate a dynamic Keep&Spin. Frames may encase select Blue and/or Red Scarabs, augmenting their quantity with each spin. Ultimately, the Red Scarab credits combine, instigating a Pick-up Jackpot Bonus featuring 15 elements.

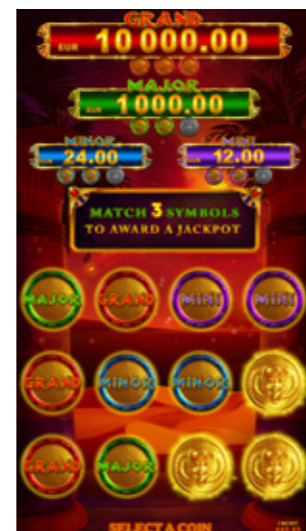

Free Spins



Keep & Spin



Jackpot bonus

Combo Bonuses

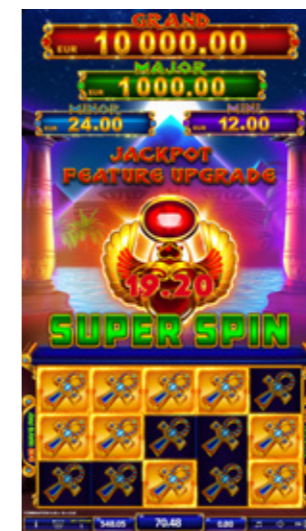
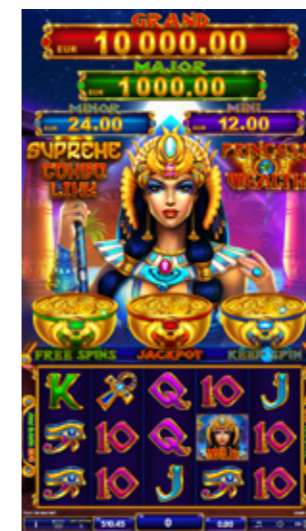

PRINCESS OF WEALTH



SUPREME COMBO LINK

Ultra Tap Link entices players for an unforgettable experience as they challenge fate itself and uncover unimaginable riches in a realm where luck is their greatest ally. The jackpot comes with 4 progressive levels that are common for all games. The jackpot feature can be triggered with every bet, and the max bet can enhance the chances of winning.

As players answer the Syren's Call for Riches, the Golden coins are the ones to watch, and if 5 of them appear and light up the screen, it's time to enjoy the Ultra TAP LINK feature, where vast riches await. There, players select from a set of chests, opening three with the same elements reveals the prizes that can vary from credits to unlocking one of the jackpot levels.

The Free Spins complete the adventure with a special Cannon symbol that doubles the winnings of the current game and grants players another Free Spin with the possibility to play up to 8 Free Spins.

AVAILABLE GAMES



AVAILABLE CABINETS

G 55 C VIP	G 50 J1 UP	G 50 C ST
G 55 J1 VIP	G 50 J2 ST	G 50 C UP
G 50 J1 ST	G 50 J2 UP	G 50 V ST
S 32-32 UP		S 32-32 ST

AVAILABLE PANELS

Each jackpot is compatible with any panel.

Premium Progressive Controller (PPC)	Ultra Tap Link
Jackpot	Multi-level progressive jackpot
Gaming Platform	EXCITER IV
SAS Protocol	SAS 6.02



The magic of the Far East inspires many seekers of vast wealth to continue their journeys and so does it here with Cai Fu Tian Jiang: an all-new Asian themed jackpot with 4 levels and exciting new features. The Mini and Minor levels are stand-alone and non-progressive, while the Grand and Major levels are progressive and linked. Players can win free games galore and even enter into a money picking stage, aiming to collect as much riches as possible.

The games available are not only a display of visual splendor, but a conduit to many hours of sensational gameplay with many bounties and joyous twists. Delving into the mystery of Asia is a plentiful experience now more than ever.

AVAILABLE GAMES



AVAILABLE CABINETS

G 55 C VIP	G 50 J1 UP	G 50 C ST
G 55 J1 VIP	G 50 J2 ST	G 50 C UP
G 50 J1 ST	G 50 J2 UP	G 50 V ST
S 32-32 UP		S 32-32 ST

AVAILABLE PANELS

Each jackpot is compatible with any panel.

Premium Progressive Controller (PPC)	Cai Fu Tian Jiang
Jackpot	Multi-level progressive jackpot
Gaming Platform	EXCITER III EXCITER IV
SAS Protocol	SAS 6.02



Sands Princess welcomes you to the kingdom of Egypt. Embark on a quest to find the numerous treasures hidden in her domain, meet pharaohs and queens. EGT's new 5-level progressive jackpot offers the chance to win big, while enjoying this classic theme.

As you tread the sands of the Pharaoh's Desert or take on different adventures with the Egyptian Tale and Sands Spirit games – all of 5 reels and 25/50 lines, always expect surprises. Should you come across at least 5 scarab symbols, a Sands Princess feature is triggered and you may win the non-progressive Mini and Minor or the Maxi progressive level are all stand-alone. The most ambitious explorers of the Sands Princess' kingdom may even reach the two linked progressive levels (Grand and Major) that will turn every sand grain into silver and gold.

Housed in a variety of cabinets, the Sands Princess features a user-selectable multi-denomination. Players may win a few or even all of the jackpot levels with any bet they make and will also be pleasantly surprised by the Free Spins bonus, accompanying their journey in Egypt.

AVAILABLE GAMES



AVAILABLE CABINETS

G 27-27 ST	G 27-27 UP
G 27-32 ST	G 27-32 UP
G 32-32 VIP	G 50-50 C VIP
S 32-32 ST	S 32-32 UP

AVAILABLE PANELS

Each jackpot is compatible with any panel.

Premium Progressive Controller (PPC)	Sands Princess
Jackpot	Multi-level progressive jackpot
Gaming Platform	EXCITER III EXCITER IV
SAS Protocol	SAS 6.02

SANDS PRINCESS



SANDS PRINCESS



The High Cash jackpot series keeps the players brimming with anticipation. The Mini and Minor (non-progressive, stand-alone) and Major and Grand (linked, progressive) levels accumulate their power from the gorgeous single games that engulf you in a fantastic journey.

It only gets better: when you get three scatter symbols, they will trigger free spins and additional surprises. The jackpots may drop with any bet. As soon as the respin feature comes to action and a main character fills all the reels, one of the Mini, Minor, Major, or Grand vaults opens.

You can also access them with the special pick-up bonus that lays out 12 magic balls before you. Choose wisely, as three collected symbols of a kind will make one of the jackpots entirely yours.

AVAILABLE GAMES



AVAILABLE CABINETS

G 55 C VIP	G 50 J1 UP	G 50 C ST
G 55 J1 VIP	G 50 J2 ST	G 50 C UP
G 50 J1 ST	G 50 J2 UP	G 50 V ST
S 32-32 UP		S 32-32 ST

AVAILABLE PANELS

Each jackpot is compatible with any panel.

Premium Progressive Controller (PPC)	High Cash
Jackpot	Multi-level progressive jackpot
Gaming Platform	EXCITER III [®] EXCITER IV [®]
SAS Protocol	SAS 6.02



The 2 Happy Hits series is a standalone mystery jackpot of 2 progressive levels – Major and Grand, that may be hit at random with any bet. The players anticipate them greatly as they have a hint as to when these jackpots are expected to drop. The “Must hit by” field shows the accumulated value before which each jackpot is sure to grant its riches.

At the heart of 2 Happy Hits are its single games that have their own theme, bonuses, rules, and distinct look and feel. Specially created to shine on the vast HD displays of the General tech-forward slot cabinets, their artwork, background music, numerous exciting visual effects, and fast and easy navigation are designed for a peak in satisfaction. Just spin the reels and feel the energy of 2 Happy Hits.

AVAILABLE GAMES



AVAILABLE CABINETS

G 55 C VIP	G 50 J1 UP	G 50 C ST
G 55 J1 VIP	G 50 J2 ST	G 50 C UP
G 50 J1 ST	G 50 J2 UP	G 50 V ST
S 32-32 UP		S 32-32 ST

Premium Progressive Controller (PPC)	2 Happy Hits
Jackpot	Standalone Mystery Jackpot
Gaming Platform	EXCITER III EXCITER IV
SAS Protocol	SAS 6.02



Diamonds are forever, and with 9 Crystal Bonanza you'll get a chance to enjoy them whenever you want. This multi-level progressive jackpot on our newest gaming platform – Exciter 4, offers a wide variety of playing options. Of course, the centerpiece is the diamond that shines brightly from our General cabinets. If more than 3 of them are scattered on the screen, you will win a substantial reward, and if you're lucky to have more than 5 Diamonds when a max bet has been placed then the jackpot is yours.

If not, you can always enjoy the bonus spins. Just get 3 Free Spin symbols to appear on the screen and get up to 10 free spins with the chance of an X2 or X3 multiplier if you manage to navigate your way to the last spin.

There is also a Wild symbol which will help you by substituting all other symbols except the Free Spin and the Diamond. Look for it on the 2nd reel.

AVAILABLE CABINETS

G 55 C VIP	G 50 J1 UP	G 50 C ST
G 55 J1 VIP	G 50 J2 ST	G 50 C UP
G 50 J1 ST	G 50 J2 UP	G 50 V ST
S 32-32 UP		S 32-32 ST

AVAILABLE PANELS

Each jackpot is compatible with any panel.

Premium Progressive Controller (PPC)	9 Crystal Bonanza
Jackpot	Multi-level progressive jackpot
Gaming Platform	EXCITER IV
SAS Protocol	SAS 6.02



Mini, Minor, Major and Grand are the four levels of this mystery progressive jackpot, a thrill ride for the General, Power and Collection multigames with a bonus game that takes you by surprise randomly, leading you to a pick-up field of 12 shiny, golden coins. Reveal their head sides, matching three of the same kind, and your journey will end in prosperity.

Each of the four levels may be hit with any bet, but the higher wager increases your chance of reaching the most glorious of all – the Grand.



Jackpot Feature screen

AVAILABLE MULTIGAMES

All multigames of the series:



AVAILABLE CABINETS

The jackpot is compatible with all cabinets of the series GENERAL, PREMIER, S 32-32 UP & S 32-32 ST.

AVAILABLE PANELS

Each jackpot is compatible with any panel.

Premium Progressive Controller (PPC)



Jackpot

Multi-Level
Mystery Jackpot

Gaming Platform



SAS Protocol

SAS 6.02



The Clubs, Diamonds, Hearts and Spades are the main characters of this four-level mystery progressive jackpot and their realm is the bonus game that triggers randomly and presents you with a pick field of 12 unrevealed cards. When they turn their face to you and after you collect three of the same suit, you will become the owner of the accumulated amount of the matching jackpot level.

You may win any level with any bet, and the higher the stakes, the higher the chances to hit the jackpot of the Spades.



Jackpot Feature screen

AVAILABLE MULTIGAMES

All multigames of the series:



AVAILABLE CABINETS

The jackpot is compatible with all cabinets of the series GENERAL, PREMIER, S 32-32 UP & S 32-32 ST.

AVAILABLE PANELS

Each jackpot is compatible with any panel.

Premium Progressive Controller (PPC)	Jackpot Cards
Jackpot	Multi-Level Mystery Jackpot
Gaming Platform	EXCITER III EXCITER IV
SAS Protocol	SAS 6.02



Premium Link is a jackpot system where EGT games from General, Power, Collection, Premier and older series like Vega Vision+ and Vega Vision can be linked together in order to participate in common mystery and symbol-driven progressive jackpots.

The Premium Link is based on Premium Progressive Controller (PPC) and Media Control Center (MCC) for visualization, and supports a mystery jackpot with up to 3 levels (Mini, Middle and Super), all of which are common for all games and denominations and fully customizable, including a setting for minimum bet requirement. The mystery jackpot values are accumulated on the grounds of stakes made on all machines participating in the jackpots and can be won randomly by each of them.

Premium Link supports symbol-driven jackpots, each with a maximum of 4 denominations and with its own independent settings. The accumulation is done on the grounds of stakes made during the games.

Gaming machines of other manufacturers also can be linked in order to participate in common mystery jackpots. For this purpose, each gaming machine has a special controller – Jackpot Interface Module (JIM). The collected jackpots are transferred to the gaming machines as Legacy bonuses via SAS Protocol.

AVAILABLE MULTIGAMES
All multigames of the series:



AVAILABLE CABINETS

The jackpot is compatible with all cabinets of the series GENERAL, PREMIER, S 32-32 UP & S 32-32 ST.

AVAILABLE PANELS

Each jackpot is compatible with any panel.

Premium Progressive Controller (PPC)	Premium Link
Jackpot	Multi-Level Mystery Jackpot
Gaming Platform	EXCITER III EXCITER IV
SAS Protocol	SAS 6.02

PREMIUM Link



Each of the Lady's Cards four jackpot levels can be won through the special Lady's Cards bonus game which can be triggered randomly at the end of each of the base games. When the Lady's Cards bonus is triggered, 12 cards appear on the screen, the player chooses which ones to reveal, and when he collects 3 cards with the same suit, he wins the corresponding jackpot level – Clubs, Diamonds, Hearts or Spades. The player may win any of the four jackpot levels without having to play the maximum bet. However, the higher the bet, the greater the chance to trigger the bonus and win the highest level.

Lady's Cards jackpot is designed for players who enjoy the added value of mystery progressive jackpots on their well-known and favorite games.

The bank of gaming machines with Lady's Cards jackpot can be individually customized through a selection of maximum bet, denominations, and jackpot values in order to satisfy the specific requirements of the players.

In addition, gaming machines of other manufacturers can be connected to the Lady's Cards jackpot system via SAS Protocol through a special controller (Premium Adapter).

AVAILABLE MULTIGAMES

All multigames of the series:

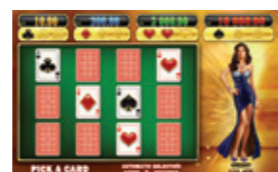

The player picks cards in order to collect 3 of the same suit and to win the corresponding jackpot level.

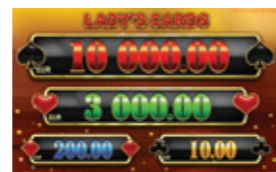

The Lady's Cards themed progressive meters complement the games with the branded jackpot concept.

AVAILABLE CABINETS

The jackpot is compatible with all cabinets of the series GENERAL, PREMIER, S 32-32 UP & S 32-32 ST.

AVAILABLE PANELS

Each jackpot is compatible with any panel.

Premium Progressive Controller (PPC)	Lady's Cards
Jackpot	Multi-Level Mystery Jackpot
Gaming Platform	EXCITER III EXCITER IV
SAS Protocol	SAS 6.02

LADY'S CARDS



The background is a solid red color. It features several sets of white, parallel lines that curve and flow across the page. One set of lines is in the top-left corner, another set is in the bottom-right corner, and a third set is in the bottom-center, framing the text. The lines have a rounded, organic feel.

CABINETS

32-32 UP



- Two high-resolution 32" UHD 4K monitors
- Main display enhanced with advanced touchscreen functionality
- Overhead multimedia topper with a 32" UHD 4K monitor (optional)
- Frameless UHD 4K display delivering outstanding visual precision
- Sophisticated design with user-friendly ergonomics for ultimate comfort
- Large 15.6" display keyboard featuring touch haptic feedback, dynamic lighting, and wide, comfortable mechanical buttons for superior usability
- Ergonomically optimized key systems designed for intuitive and efficient operator use
- High-quality 2.1 DSP sound system for an immersive audio experience
- Dynamic and stylish LED lighting enhances the cabinet's visual appeal
- Dynamic RGB monitors backlight for customizable and immersive lighting effects
- Built-in USB A and USB C ports for fast charging
- Integrated Wireless Charger for effortless device charging
- Powered by the **EXCITER IV**™—a cutting-edge platform that delivers unmatched power and performance

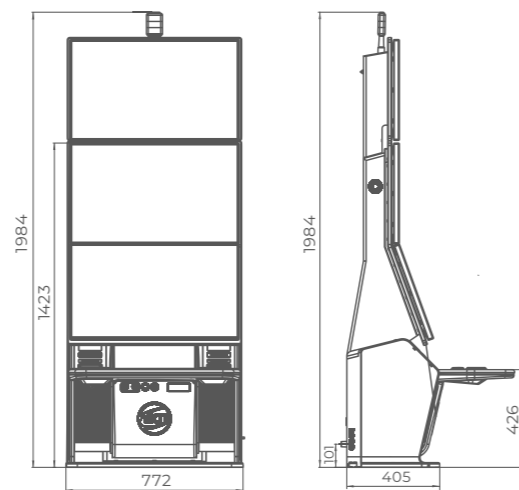

32-32 ST



- Two high-resolution 32" UHD 4K monitors
- Main display enhanced with advanced touchscreen functionality
- Overhead multimedia topper with a 32" UHD 4K monitor (optional)
- Frameless UHD 4K display delivering outstanding visual precision
- Sophisticated design with user-friendly ergonomics for ultimate comfort
- Large 15.6" display keyboard featuring touch haptic feedback, dynamic lighting, and wide, comfortable mechanical buttons for superior usability
- Ergonomically optimized key systems designed for intuitive and efficient operator use
- High-quality 2.1 DSP sound system for an immersive audio experience
- Dynamic and stylish LED lighting enhances the cabinet's visual appeal
- Dynamic RGB monitors backlight for customizable and immersive lighting effects
- Built-in USB A and USB C ports for fast charging
- Integrated Wireless Charger for effortless device charging
- Powered by the **EXCITER IV**™—a cutting-edge platform that delivers unmatched power and performance

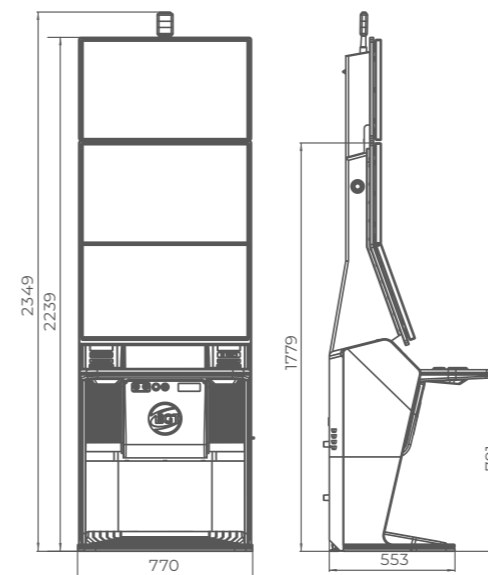

G 50-50 C VIP



- Two 50" frameless HD displays with exceptional visual clarity
- Exquisite design and ergonomic features, ensuring maximum comfort
- Wide and convenient keyboard with dynamic touch display and electromechanical buttons
- Specially designed key systems for more ease of use by an operator
- High-quality stereo sound system
- Ambient, attractive LED illumination alongside the cabinet
- Built-in USB port for fast charging
- Powered by the **EXCITER III** and **EXCITER IV** platforms

Comfortable multimedia chair that includes:

- High-quality stereo sound speakers
- Sound volume control
- The functions: Start, Auto Play, Select Game, Gamble, Take Win, Select Bet and Lines

Dynamic touch keyboard

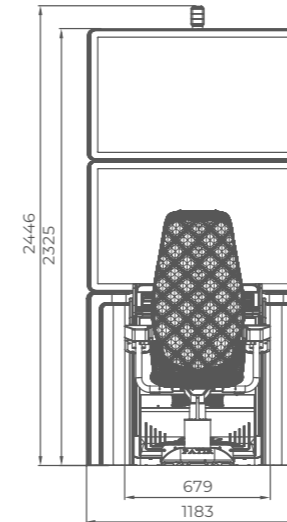
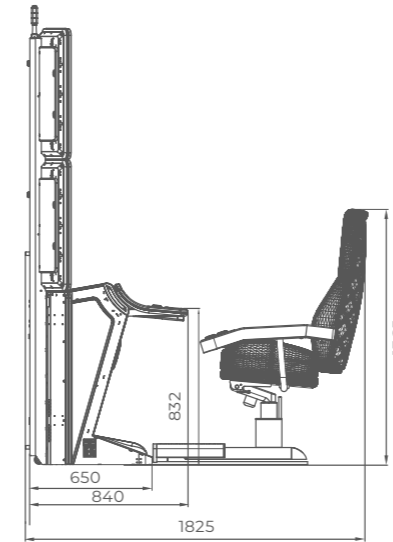
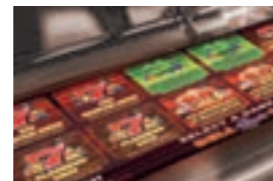

G 55 J1 VIP



- 55" J-curved frameless HD display with exceptional visual clarity
- Exquisite design and ergonomic features, ensuring maximum comfort
- Wide and convenient keyboard with dynamic touch display and electromechanical buttons
- Specially designed key systems for more ease of use by an operator
- High-quality stereo sound system
- Ambient, attractive LED illumination alongside the cabinet
- Built-in USB port for fast charging
- Powered by the **EXCITER III** and **EXCITER IV** platforms

Comfortable multimedia chair that includes:

- High-quality stereo sound speakers
- Sound volume control
- The functions: Start, Auto Play, Select Game, Gamble, Take Win, Select Bet and Lines

Dynamic touch keyboard

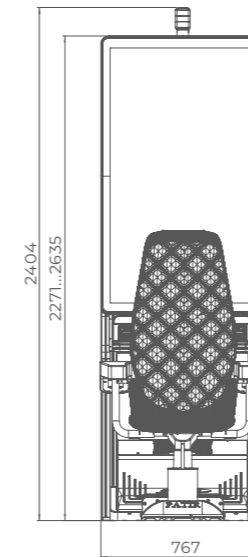
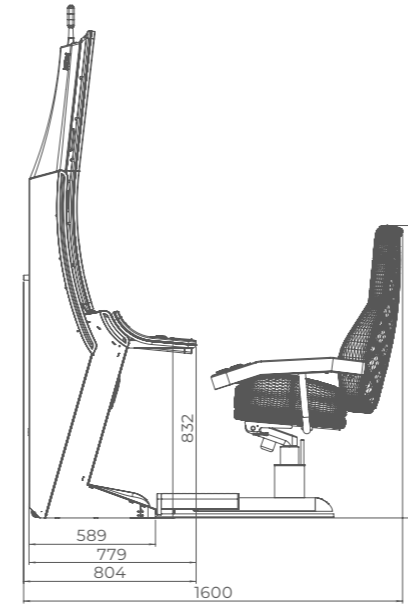
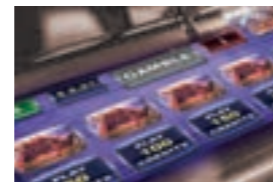

G 55 C VIP



- 55" curved frameless HD display with exceptional visual clarity
- Integrated touchscreen
- Exquisite design and ergonomic features, ensuring maximum comfort
- Wide and convenient keyboard with dynamic touch display and electromechanical buttons
- Specially designed key systems for more ease of use by an operator
- High-quality stereo sound system
- Ambient, attractive LED illumination alongside the cabinet
- Built-in USB port for fast charging
- Powered by the **EXCITER III** and **EXCITER IV** platforms

Comfortable multimedia chair that includes:

- High-quality stereo sound speakers
- Sound volume control
- The functions: Start, Auto Play, Select Game, Gamble, Take Win, Select Bet and Lines

Dynamic touch keyboard

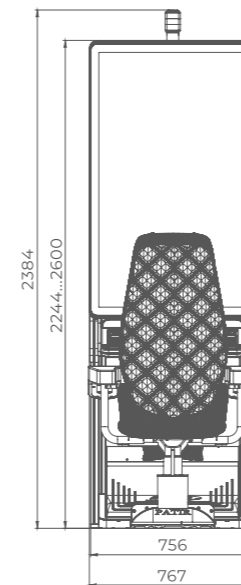
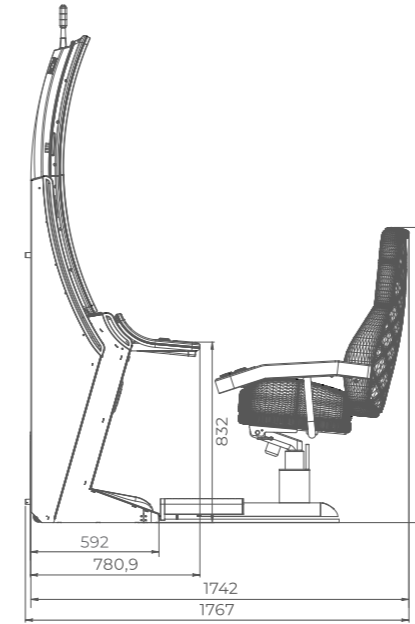

G 32-32 VIP



- Two high-resolution 32" widescreen monitors
- Touch screen equipped on the main display
- Overhead multimedia topper with a 32" monitor (optional)
- Frameless HD display with exceptional visual clarity
- Exquisite design and ergonomic features, ensuring maximum comfort
- Wide and convenient keyboard with dynamic touch display and electromechanical buttons
- Specially designed key systems for more ease of use by an operator
- High-quality stereo sound system
- Ambient, attractive LED illumination alongside the cabinet
- Built-in USB port for fast charging
- Powered by the **EXCITER III** and **EXCITER IV** platforms

Comfortable multimedia chair that includes:

- High-quality stereo sound speakers
- Sound volume control
- The functions: Start, Auto Play, Select Game, Gamble, Take Win, Select Bet and Lines

Dynamic touch keyboard



Multimedia topper (optional)

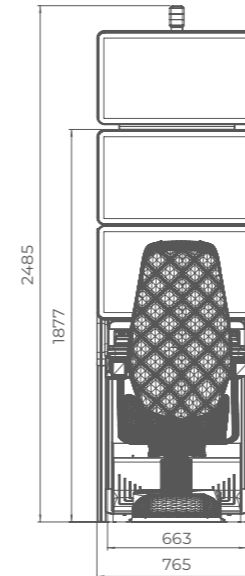
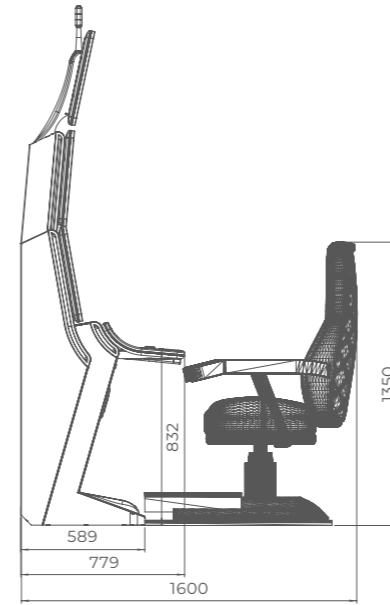
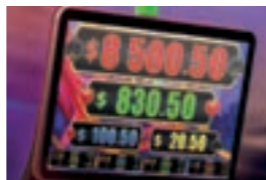

G 50 V ST



- A 50" portrait-oriented straight display with integrated touch screen for greater interactivity
- Overhead multimedia topper with a 27" monitor (optional)
- Frameless HD display with exceptional visual clarity
- Exquisite design and ergonomic features, ensuring maximum comfort
- Wide and convenient keyboard with dynamic touch display and electromechanical buttons
- Specially designed key systems for more ease of use by an operator
- High-quality stereo sound system
- Ambient, attractive LED illumination alongside the cabinet
- Built-in USB port for fast charging
- Powered by the **EXCITER III**® and **EXCITER IV**® platforms



Dynamic touch keyboard

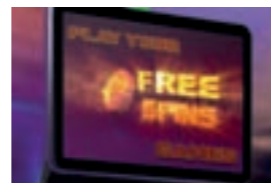

Multimedia topper (optional)

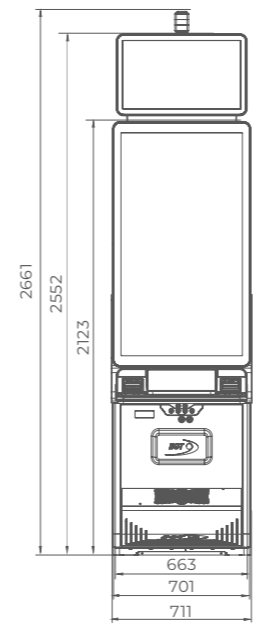
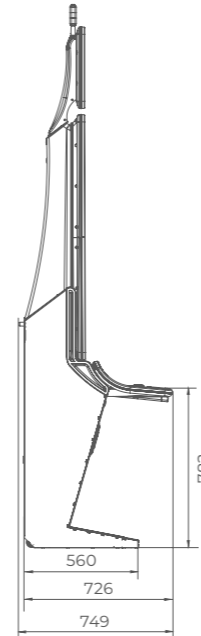

G 50 J1 UP

- A 50" portrait-oriented J-curved display with integrated touch screen for greater interactivity
- Overhead multimedia topper with a 27" monitor (optional)
- Frameless HD display with exceptional visual clarity
- Exquisite design and ergonomic features, ensuring maximum comfort
- Wide and convenient keyboard with dynamic touch display and electromechanical buttons
- Specially designed key systems for more ease of use by an operator
- High-quality stereo sound system
- Ambient, attractive LED illumination alongside the cabinet
- Built-in USB port for fast charging
- Powered by the **EXCITER III** and **EXCITER IV** platforms

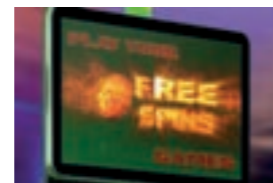
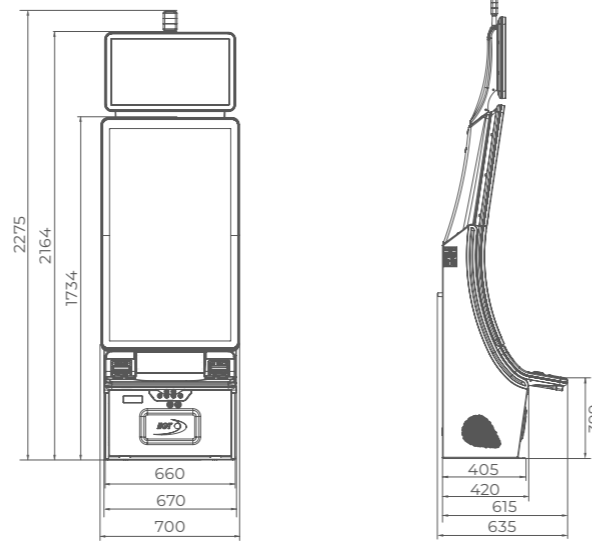

Multimedia topper (optional)



Dynamic touch keyboard

G 50 J1 ST

- A 50" portrait-oriented J-curved display with integrated touch screen for greater interactivity
- Overhead multimedia topper with a 27" monitor (optional)
- Frameless HD display with exceptional visual clarity
- Exquisite design and ergonomic features, ensuring maximum comfort
- Wide and convenient keyboard with dynamic touch display and electromechanical buttons
- Specially designed key systems for more ease of use by an operator
- High-quality stereo sound system
- Ambient, attractive LED illumination alongside the cabinet
- Built-in USB port for fast charging
- Powered by the **EXCITER III** and **EXCITER IV** platforms

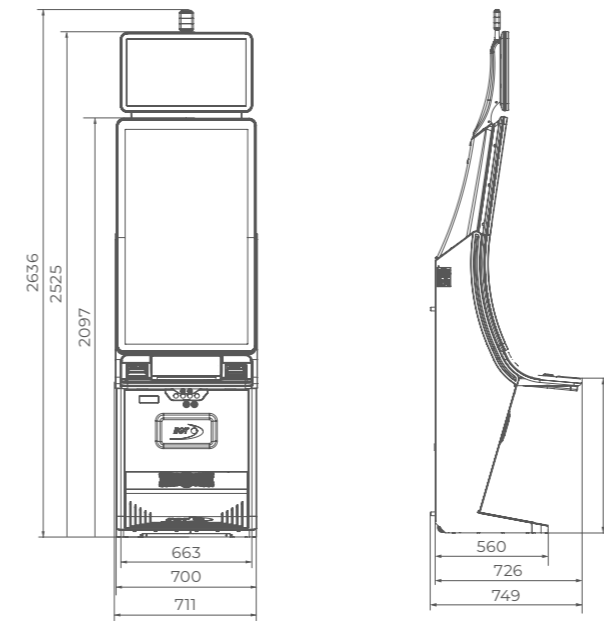

Multimedia topper (optional)

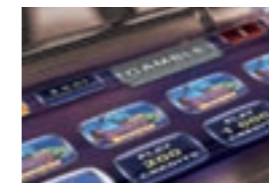

Dynamic touch keyboard



G 50 J2 UP

- A 50" portrait-oriented J-curved display with integrated touch screen for greater interactivity
- Overhead multimedia topper with a 27" monitor (optional)
- Frameless HD display with exceptional visual clarity
- Exquisite design and ergonomic features, ensuring maximum comfort
- Wide and convenient keyboard with dynamic touch display and electromechanical buttons
- Specially designed key systems for more ease of use by an operator
- High-quality stereo sound system
- Ambient, attractive LED illumination alongside the cabinet
- Built-in USB port for fast charging
- Powered by the **EXCITER III**® and **EXCITER IV**® platforms

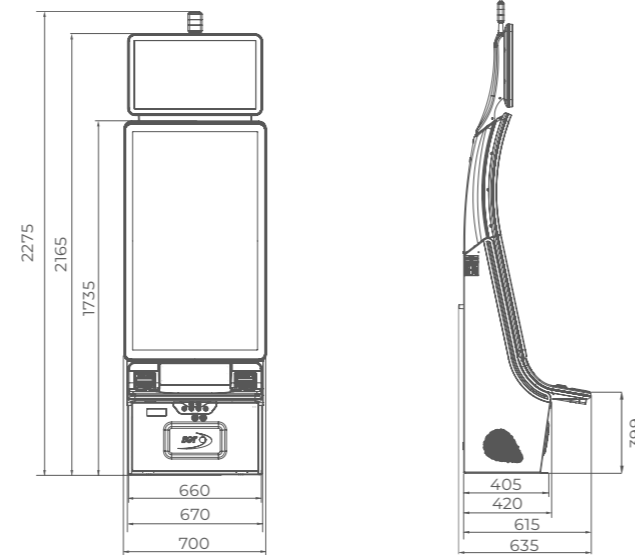

Multimedia topper (optional)



Dynamic touch keyboard

G 50 J2 ST

- A 50" portrait-oriented J-curved display with integrated touch screen for greater interactivity
- Overhead multimedia topper with a 27" monitor (optional)
- Frameless HD display with exceptional visual clarity
- Exquisite design and ergonomic features, ensuring maximum comfort
- Wide and convenient keyboard with dynamic touch display and electromechanical buttons
- Specially designed key systems for more ease of use by an operator
- High-quality stereo sound system
- Ambient, attractive LED illumination alongside the cabinet
- Built-in USB port for fast charging
- Powered by the **EXCITER III**® and **EXCITER IV**® platforms

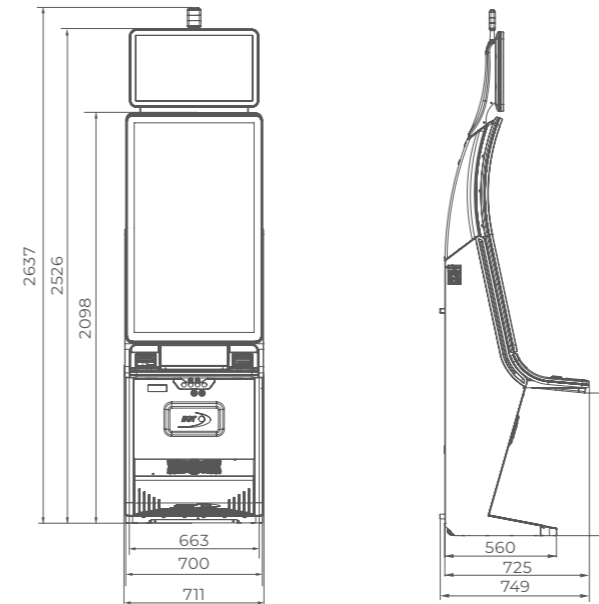

Multimedia topper (optional)

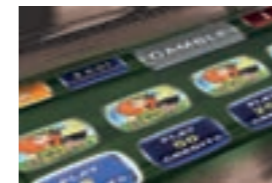

Dynamic touch keyboard



G 50 C UP

- A 50" portrait-oriented curved display with interactive touch screen
- Overhead multimedia topper with a 27" monitor (optional)
- Frameless HD display with exceptional visual clarity
- Exquisite design and ergonomic features, ensuring maximum comfort
- Wide and convenient keyboard with dynamic touch display and electromechanical buttons
- Specially designed key systems for more ease of use by an operator
- High-quality stereo sound system
- Ambient, attractive LED illumination alongside the cabinet
- Built-in USB port for fast charging
- Powered by the **EXCITER III**® and **EXCITER IV**® platforms

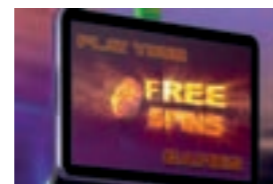
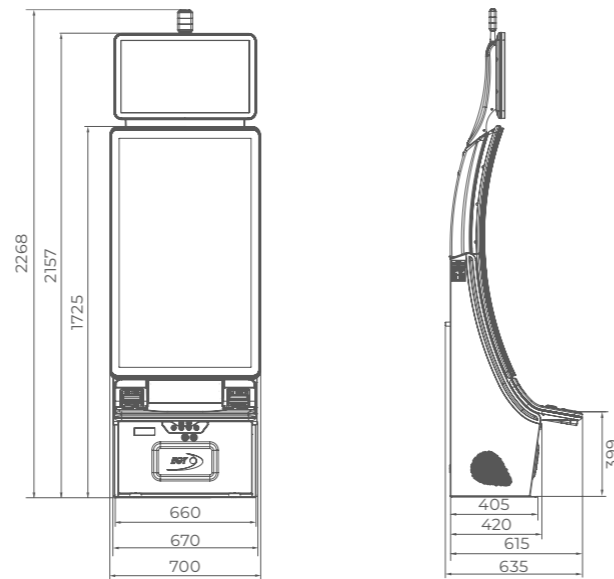

Multimedia topper (optional)

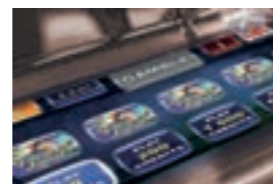

Dynamic touch keyboard

G 50 C ST

- A 50" portrait-oriented curved display with interactive touch screen
- Overhead multimedia topper with a 27" monitor (optional)
- Frameless HD display with exceptional visual clarity
- Exquisite design and ergonomic features, ensuring maximum comfort
- Wide and convenient keyboard with dynamic touch display and electromechanical buttons
- Specially designed key systems for more ease of use by an operator
- High-quality stereo sound system
- Ambient, attractive LED illumination alongside the cabinet
- Built-in USB port for fast charging
- Powered by the **EXCITER III**® and **EXCITER IV**® platforms

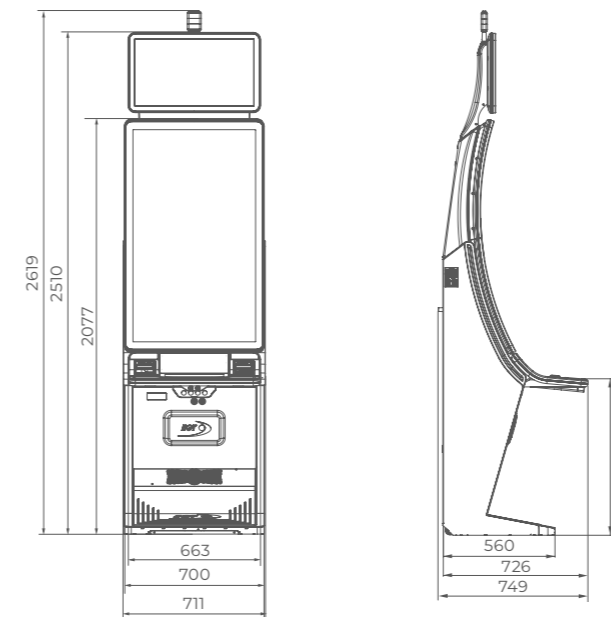

Multimedia topper (optional)

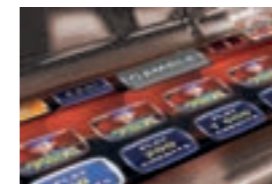

Dynamic touch keyboard



G 27-32 UP

- A high-resolution 27" main monitor with integrated touch screen and a 32" upper widescreen display
- Overhead multimedia topper with a 32" monitor (optional)
- Frameless HD display with exceptional visual clarity
- Exquisite design and ergonomic features, ensuring maximum comfort
- Wide and convenient keyboard with dynamic touch display and electromechanical buttons
- Specially designed key systems for more ease of use by an operator
- High-quality stereo sound system
- Ambient, attractive LED illumination alongside the cabinet
- Built-in USB port for fast charging
- Powered by the **EXCITER III**® and **EXCITER IV**® platforms

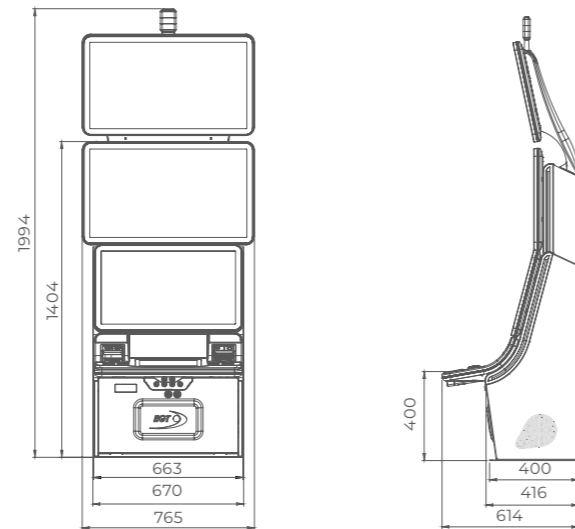

Multimedia topper (optional)



Dynamic touch keyboard

G 27-32 ST

- A high-resolution 27" main monitor with integrated touch screen and a 32" upper widescreen display
- Overhead multimedia topper with a 32" monitor (optional)
- Frameless HD display with exceptional visual clarity
- Exquisite design and ergonomic features, ensuring maximum comfort
- Wide and convenient keyboard with dynamic touch display and electromechanical buttons
- Specially designed key systems for more ease of use by an operator
- High-quality stereo sound system
- Ambient, attractive LED illumination alongside the cabinet
- Built-in USB port for fast charging
- Powered by the **EXCITER III**® and **EXCITER IV**® platforms

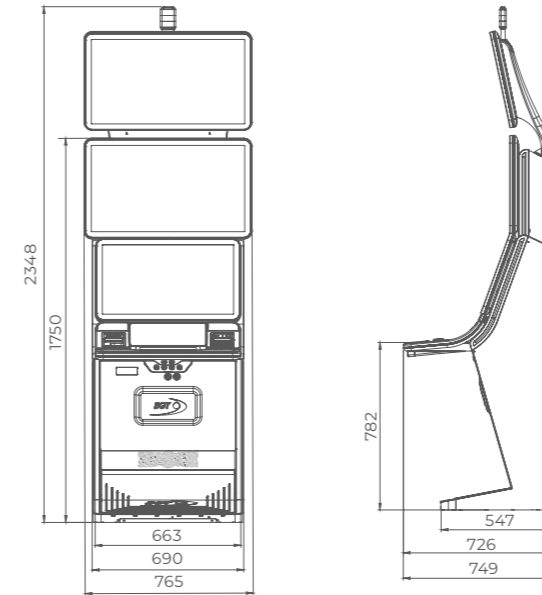

Multimedia topper (optional)

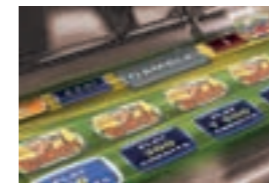

Dynamic touch keyboard



G 27-27 UP

- Two high-resolution 27" widescreen monitors
- Touch screen equipped on the main display
- Overhead multimedia topper with a 27" monitor (optional)
- Frameless HD display with exceptional visual clarity
- Exquisite design and ergonomic features, ensuring maximum comfort
- Wide and convenient keyboard with dynamic touch display and electromechanical buttons
- Specially designed key systems for more ease of use by an operator
- High-quality stereo sound system
- Ambient, attractive LED illumination alongside the cabinet
- Built-in USB port for fast charging
- Powered by the **EXCITER III** and **EXCITER IV** platforms

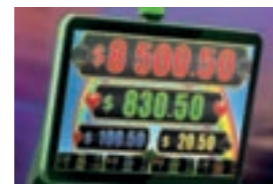
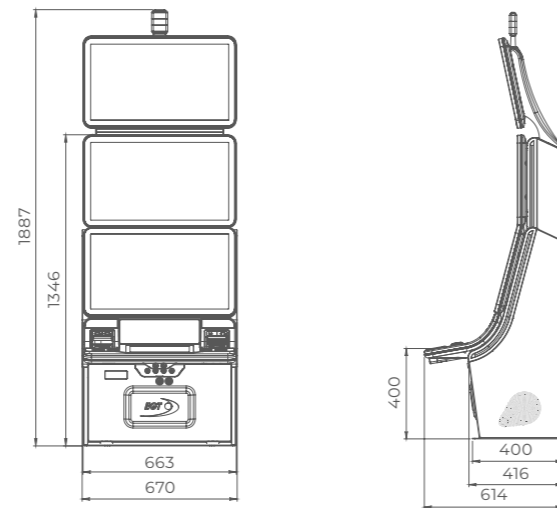

Multimedia topper (optional)

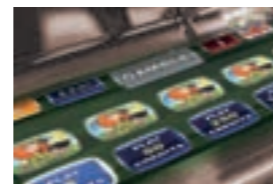

Dynamic touch keyboard

G 27-27 ST

- Two high-resolution 27" widescreen monitors
- Touch screen equipped on the main display
- Overhead multimedia topper with a 27" monitor (optional)
- Frameless HD display with exceptional visual clarity
- Exquisite design and ergonomic features, ensuring maximum comfort
- Wide and convenient keyboard with dynamic touch display and electromechanical buttons
- Specially designed key systems for more ease of use by an operator
- High-quality stereo sound system
- Ambient, attractive LED illumination alongside the cabinet
- Built-in USB port for fast charging
- Powered by the **EXCITER III** and **EXCITER IV** platforms

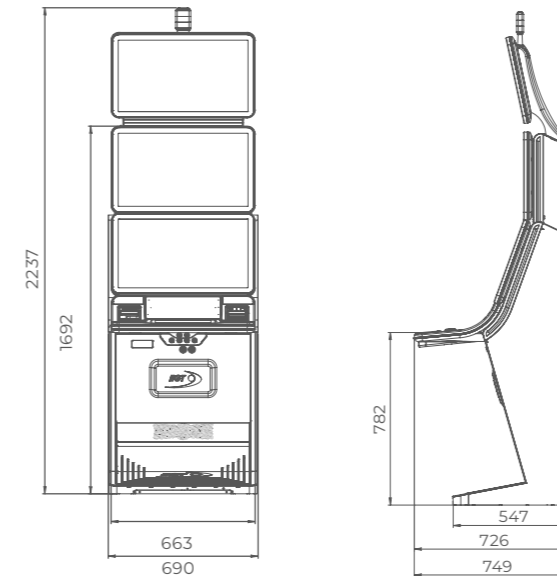

Multimedia topper (optional)

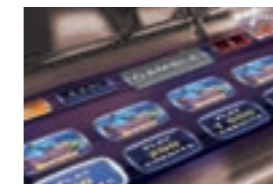

Dynamic touch keyboard



Phoenix

- Two high-resolution 27" widescreen monitors
- Overhead multimedia topper with a 27" monitor (optional)
- Exquisite design and ergonomic features, ensuring maximum comfort
- Keyboard with dynamic touch display and electromechanical buttons
- Ambient, attractive LED illumination alongside the cabinet
- Latest EGT software available
- Powered by the **EXCITER IV**® platforms

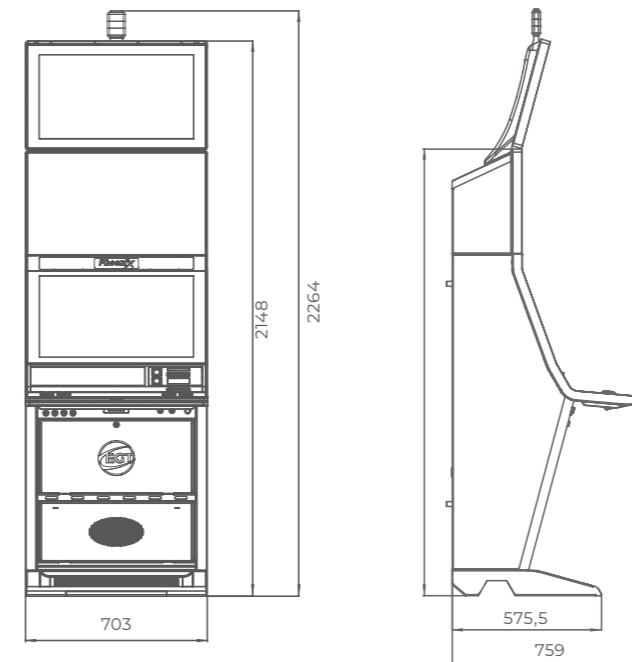

PH 27-27 ST



The background is a solid red color. It features several sets of white, parallel lines that curve and flow across the page. One set of lines is in the top-left corner, another set is in the bottom-right corner, and a large set of lines curves from the bottom-left towards the right side of the page. The text is centered in the upper-middle part of the page.

**ELECTRONIC
TABLE GAMES**

S 32 T new

- High-resolution 32" UHD 4K monitor
- Display enhanced with advanced touchscreen functionality
- Frameless UHD 4K display delivering outstanding visual precision
- Sophisticated design with user-friendly ergonomics for ultimate comfort
- Keyboard with 4/11 comfortable mechanical buttons for superior usability and dynamic lighting
- Ergonomically optimized key systems designed for intuitive and efficient operator use
- High-quality 2.1 DSP sound system for an immersive audio experience
- Dynamic and stylish LED lighting that enhances the terminal's visual appeal
- Dynamic and stylish LED lighting that enhances the cabinet's visual appeal
- Dynamic RGB backlight for customizable and immersive lighting effects

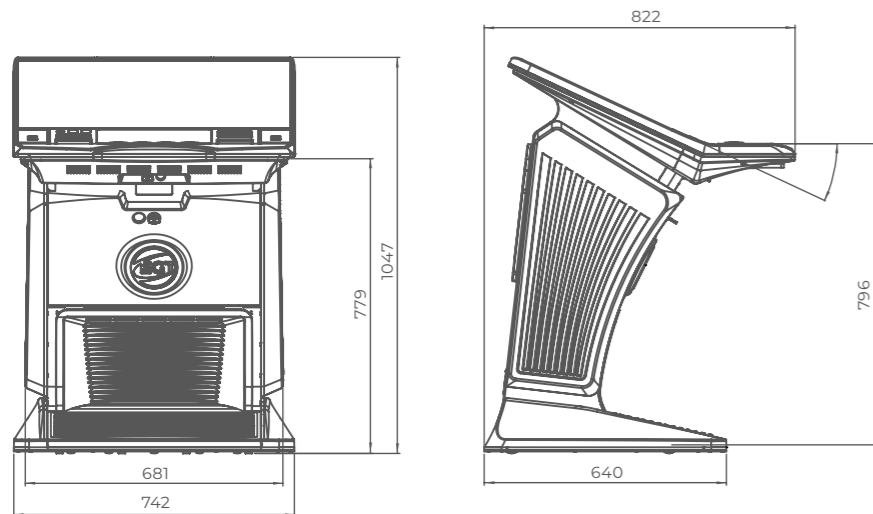

- Built-in USB A and USB C ports for fast charging
- Integrated wireless charger for effortless device charging
- Powered by the **EXCITER IV**—a cutting-edge platform that delivers unmatched power and performance



GS Series

Experience the pinnacle of gaming luxury with the GS series. The Ultimate GS 32 T boasts a frameless 32" display and modular construction for endless configurations. Engage directly with gameplay using the integrated touch screen of the GS 32-32, while the GS 32-32-32 elevates multiplayer immersion with three dynamic monitors.



GS 32 T

- Exquisite design with a frameless 32" display that reproduces pictures with exceptional clarity
- Modular construction, allowing many possible configurations
- Easy integration into roulettes, roulette groups, etc.
- Ergonomic features, ensuring maximum comfort for the players
- Different keyboard options are available (6 or 13 electromechanical buttons are the options of the available keyboards);
- Specially designed for more ease of use
- High-quality stereo sound system
- Ambient, attractive LED illumination alongside the cabinet
- Built-in USB port for fast charging

Peripheral devices:

- Bill validator (optional)
- Ticket printer (optional)

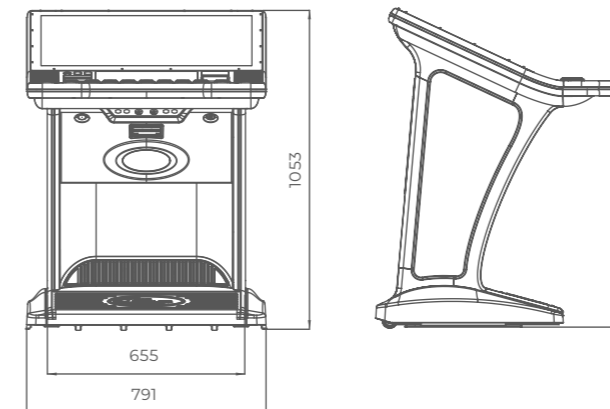

GS 32-32

- A high-resolution 32" main monitor with integrated touch screen and a 32" upper widescreen display
- Easy integration into roulettes, roulette groups, etc.
- Ergonomic features, ensuring maximum comfort for the players
- Wide and convenient keyboard with dynamic touch display and electromechanical buttons
- Specially designed for more ease of use
- High-quality stereo sound system
- Ambient, attractive LED illumination alongside the cabinet
- Built-in USB port for fast charging
- Powered by the Exciter IV platform

Peripheral devices:

- Bill validator (optional)
- Ticket printer (optional)

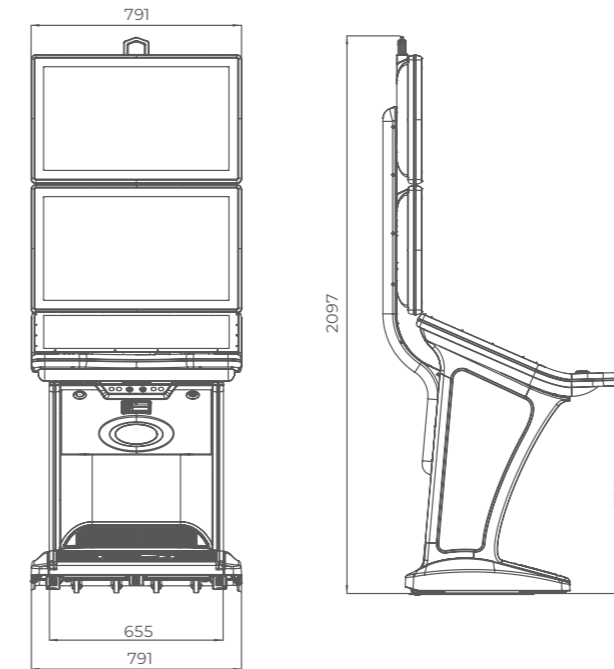
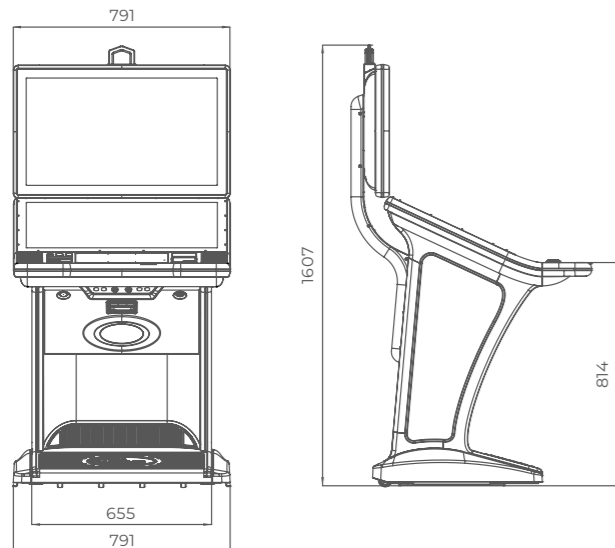

GS 32-32-32

- A high-resolution 32" main monitor with integrated touch screen, 32" upper widescreen display and a third 32" top monitor
- Easy integration into roulettes, roulette groups, etc.
- Ergonomic features, ensuring maximum comfort for the players
- Wide and convenient keyboard with dynamic touch display and electromechanical buttons
- Specially designed for more ease of use
- High-quality stereo sound system
- Ambient, attractive LED illumination alongside the cabinet
- Built-in USB port for fast charging
- Powered by the Exciter IV platform

Peripheral devices:

- Bill validator (optional)
- Ticket printer (optional)



G 27 T

- High-resolution 27" widescreen main display with integrated touch screen for greater interactivity
- Exquisite design with a frameless display that reproduces pictures with exceptional clarity
- Modular construction, allowing many possible configurations
- Easy integration into roulettes, roulette groups, etc.
- Ergonomic features, ensuring maximum comfort for the players
- Different keyboard options are available (6 or 13 electromechanical buttons are the options of the available keyboards);
- Specially designed for more ease of use:
 - Higher security door open key system
 - Well-positioned mechanical counters for easy access and good visibility
 - Most convenient access via electronic key system
- High-quality stereo sound system
- Ambient, attractive LED illumination alongside the cabinet
- Built-in USB port for fast charging

Peripheral devices:

- Bill validator (optional)
- Ticket printer (optional)

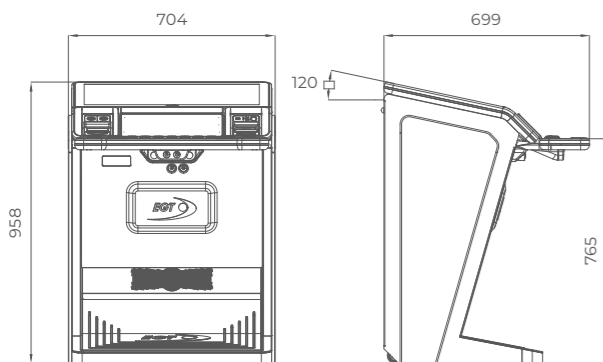

G 32 T

- High-resolution 32" widescreen main display with integrated touch screen for greater interactivity
- Exquisite design with a frameless display that reproduces pictures with exceptional clarity
- Modular construction, allowing many possible configurations
- Easy integration into roulettes, roulette groups, etc.
- Ergonomic features, ensuring maximum comfort for the players
- Different keyboard options are available (6 or 13 electromechanical buttons are the options of the available keyboards)
- Specially designed for more ease of use:
 - Higher security door open key system
 - Well-positioned mechanical counters for easy access and good visibility
 - Most convenient access via electronic key system
- High-quality stereo sound system
- Ambient, attractive LED illumination alongside the cabinet
- Built-in USB port for fast charging

Peripheral devices:

- Bill validator (optional)
- Ticket printer (optional)

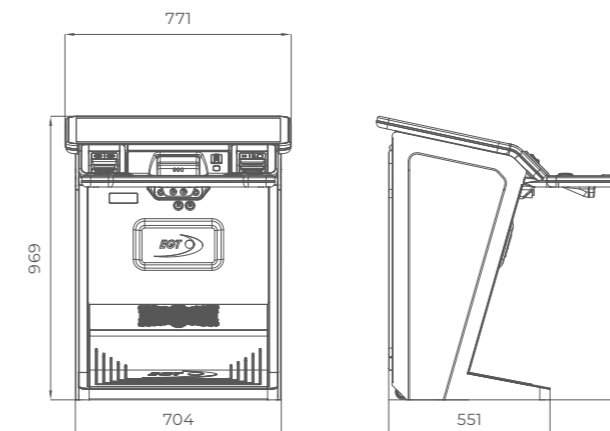

ROULETTE COMPACT 6 new

The new RK6C roulette offers a state-of-the-art gaming experience with its sleek design and advanced features. Players will appreciate the comfortable play stations, dynamic LED lighting, and engaging sound effects. The system's versatility

- 6 x 24" Full HD Touch Screen play stations and 25° monitor angle for the best player experience
- Integrated EGT Automatic Roulette Center unit
- New flat dome design for better player visibility
- Different keyboard options are available (6 or 13 electromechanical buttons are the options of the available keyboards)
- American roulette (Optional)
- Dynamic LED illuminations
- Dynamic "in-game" sound effects
- Full HD live-stream camera
- Play stations can be linked to additional EGT Automated Roulette

includes options for keyboard configurations, American roulette, and connectivity to other EGT Automated Roulette units, enhancing the overall experience.

- New 50" Dual Display visualization (Optional)
- Bill validator (Optional)
- USB charger type A and C
- Ticket printer device (Optional)

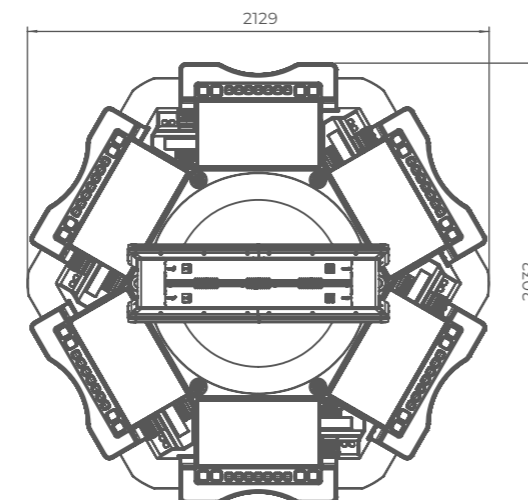
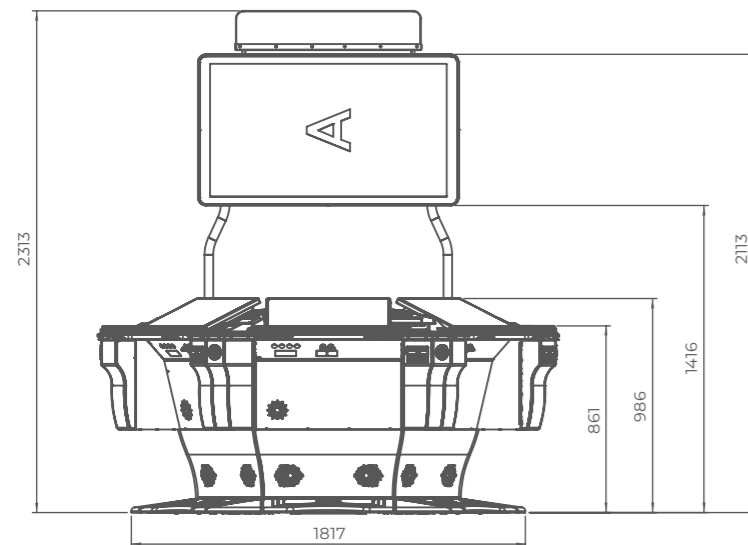

G R6 C

“G R6 C” series roulettes are the next-generation level of products. The exquisite, modern design with 27” HD monitors present a contemporary solution for the casino around the world.

Supporting all the HD multi games produced by EGT, this product can be easily turned from ± classic roulette game into a hybrid gaming machine with many slots, cards, and dice games.

- 6 x 27” Full HD Touch Screen play stations and 12° monitor angle for the best player experience
- 6 x Middle connections with sleek design
- Integrated EGT Automatic Roulette Center unit
- New dome design for better player visibility
- Different keyboard options are available (6 or 13 electromechanical buttons are the options of the available keyboards)
- American roulette (Optional)
- Dynamic LED illuminations
- Dynamic “in-game” sound effects
- Full HD live-stream camera
- Play stations can be linked to additional EGT Automated Roulette
- 50” Dual Display visualization (Optional)
- Bill validator (Optional) & USB charger;
- Ticket printer device (Optional).

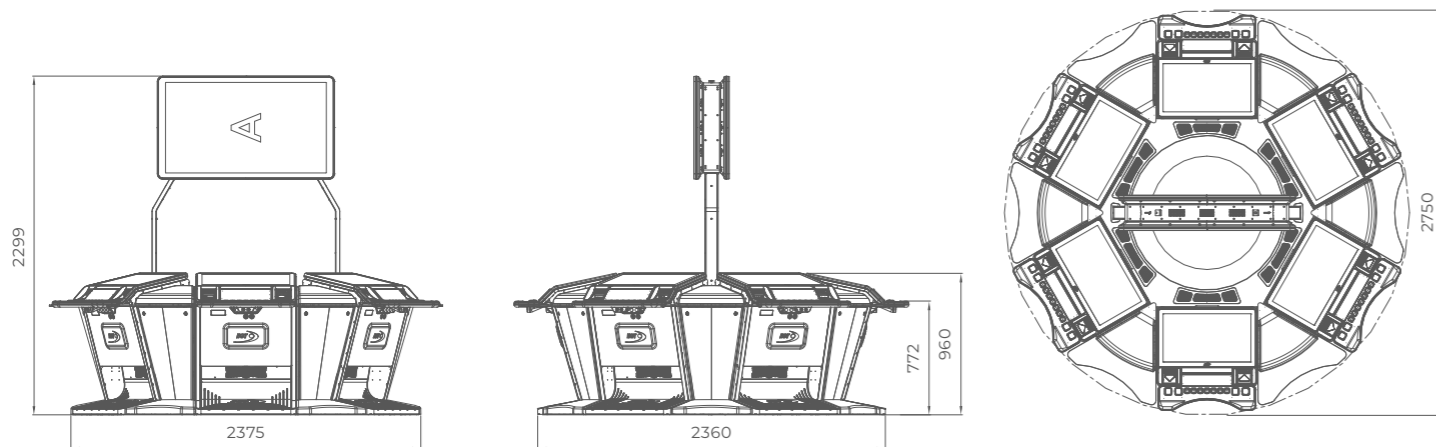

G R8 SQ

“G R8 SQ” is the latest representative of our next-generation of products. The exquisite, modern design with 27” HD monitors presents a contemporary solution for casinos worldwide.

Supporting all the HD multigame products produced by EGT, this product can be easily turned from a classic roulette game into a hybrid gaming machine with many slots, cards, and dice games.

- 8 x 27” Full HD Touch Screen play stations and 12° monitor angle for the best player experience
- 8 x Middle connections (4 x Straight and 4 x 90 degrees connections) with sleek design
- Integrated EGT Automatic Roulette Center unit
- New dome design for better player’s visibility
- Different keyboard options are available (6 or 13 electromechanical buttons are the options of the available keyboards)
- American roulette (Optional)
- Dynamic LED illuminations
- Dynamic “in-game” sound effects
- Full HD live-stream camera
- Play stations can be linked to additional EGT Automated Roulette

- 50” Four-sided Display visualization (Optional)
- 55” Dual Display visualization with an innovative lever locking mechanism for easier servicing (Optional)
- Bill validator (Optional) & USB charger
- Ticket printer device (Optional)

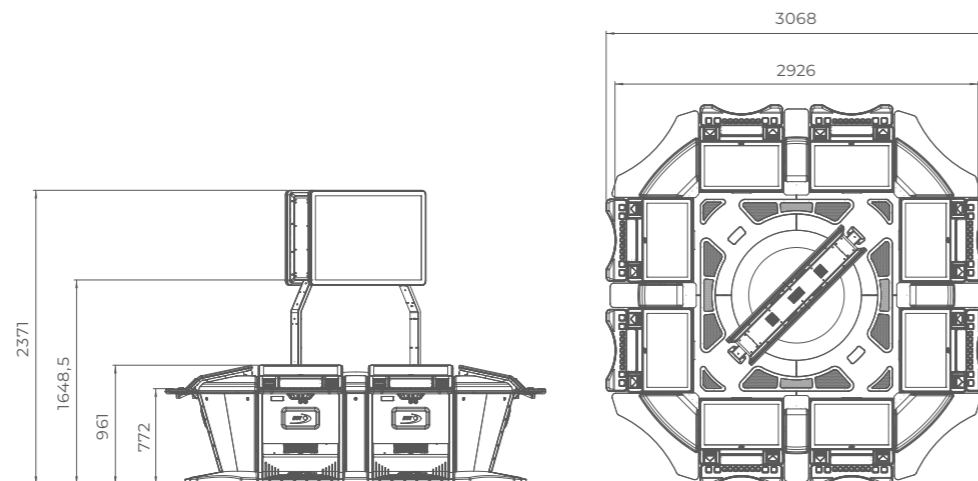

G R6 SQ

Tailor your casino experience with the “G R6 SQ” and its modern design, featuring six 27” HD monitors for players to enjoy. This product supports all HD multigames by EGT and seamlessly transforms from a classic roulette game into a hybrid gaming machine, offering various slots, cards, and dice games.



G R4 SQ

Experience the full advantages of our premium roulette in even the most compact venues with “G R4 SQ”. This sleek design, equipped with four 27” HD monitors, effortlessly supports all HD multigame products from EGT. The versatile machine transitions from a classic roulette game to a hybrid gaming console, offering a variety of slots, cards, and dice games.



G RSA

- Can be connected to all EGT play stations
- New dome design for better visibility
- HQ live stream camera
- Custom LED illumination (Red, Green, or Blue color options)
- Improved surround system with “in-game” sound effects
- 16 diamonds for an even more thrilling game experience
- American roulette (Optional)
- Available with 27” Vertical Display Visualization (Dual Sided)
- 50” Dual Display visualization (Optional)
- Detailed roulette statistics through the EGT control system

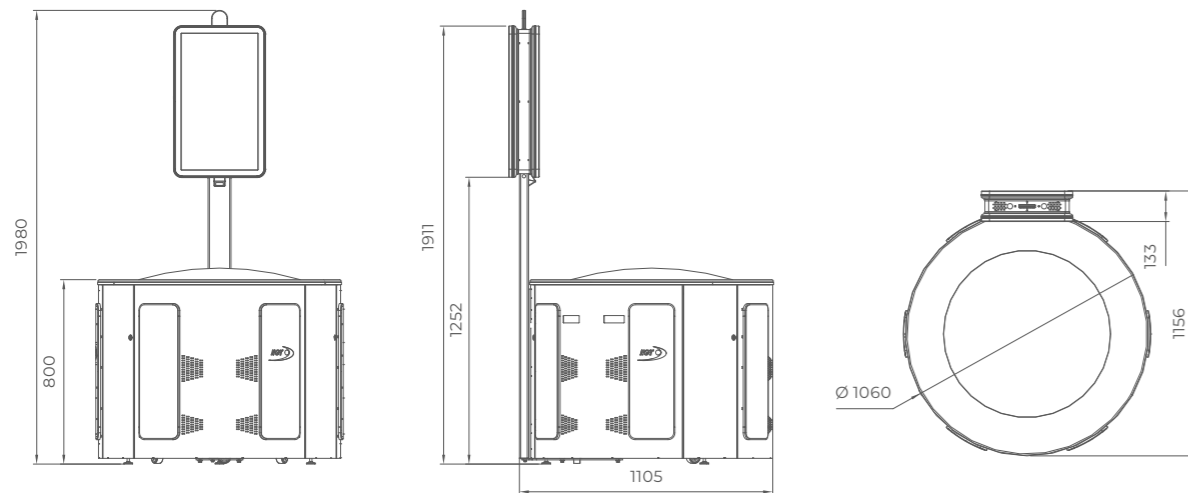

Standalone Automatic Roulette center that can be easily connected to many game stations.



The background is a solid red color. Overlaid on this are several white lines that form a large, stylized letter 'M'. The 'M' is composed of multiple parallel lines, with the top and bottom horizontal bars being thicker than the vertical stems. The lines are slightly offset from each other, creating a sense of depth and movement. The overall effect is a modern, geometric design.

MULTIGAMES



SUPREME

BONUS BUY PRIZE SELECTION

Jackpots	Coin jackpot Jackpot Cards System Premium Link Jackpot System Lady's Card Jackpot System SAS-Progressive																				
Options & Features	Multi-denomination Autoplay Gamble Multi-language																				
Platform	EXCITER IV																				
SAS Protocol	SAS 6.03																				
Cabinets	<table border="0"> <tr> <td>G 50 C ST</td> <td>G 50 C UP</td> </tr> <tr> <td>G 50 J1 ST</td> <td>G 50 J1 UP</td> </tr> <tr> <td>G 50 J2 ST</td> <td>G 50 J2 UP</td> </tr> <tr> <td>G 27-27 ST</td> <td>G 27-27 UP</td> </tr> <tr> <td>G 27-32 ST</td> <td>G 27-32 UP</td> </tr> <tr> <td>G 50 V ST</td> <td>G 55 C VIP</td> </tr> <tr> <td>G 55 J1 VIP</td> <td>G 32-32 VIP</td> </tr> <tr> <td>GS 32-32</td> <td>GS 32-32-32</td> </tr> <tr> <td>PH 27-27 ST</td> <td>G 50-50 C VIP</td> </tr> <tr> <td>S 32-32 ST</td> <td>S 32-32 UP</td> </tr> </table>	G 50 C ST	G 50 C UP	G 50 J1 ST	G 50 J1 UP	G 50 J2 ST	G 50 J2 UP	G 27-27 ST	G 27-27 UP	G 27-32 ST	G 27-32 UP	G 50 V ST	G 55 C VIP	G 55 J1 VIP	G 32-32 VIP	GS 32-32	GS 32-32-32	PH 27-27 ST	G 50-50 C VIP	S 32-32 ST	S 32-32 UP
G 50 C ST	G 50 C UP																				
G 50 J1 ST	G 50 J1 UP																				
G 50 J2 ST	G 50 J2 UP																				
G 27-27 ST	G 27-27 UP																				
G 27-32 ST	G 27-32 UP																				
G 50 V ST	G 55 C VIP																				
G 55 J1 VIP	G 32-32 VIP																				
GS 32-32	GS 32-32-32																				
PH 27-27 ST	G 50-50 C VIP																				
S 32-32 ST	S 32-32 UP																				

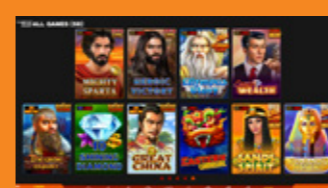
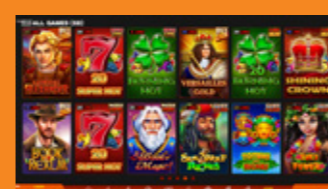
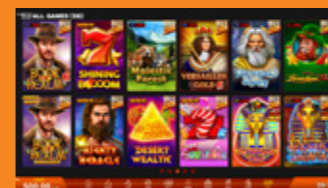
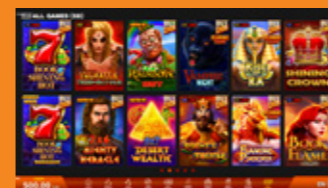
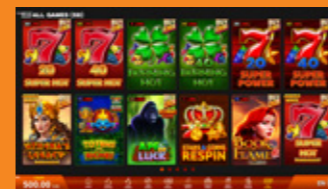

SUPREME

BONUS BUY PRIZE SELECTION

new

- | | | |
|---|--------------------------------------|------------------------------------|
| 1 20 Super Hot Bonus Buy | 20 Burning Hot Bonus Buy | 41 Book of Flame 6 Reels Bonus Buy |
| 2 Athena's Legacy Jumboways | 21 Ape of Luck Flaming Cash | 42 Rise of Ra Flaming Cash |
| 3 Book of Shining Hot Bonus Buy | 22 Rainbow Hot | 43 Flaming Phoenix Flaming Cash |
| 4 Book of Shining Hot Jumboways | 23 6x7 Desert Wealth | 44 Olympus Glory Bonus Buy |
| 5 Book of Realm 6 Reels Bonus Buy | 24 Majestic Forest Bonus Buy | 45 Egyptian Tale Cash Heat |
| 6 Book of Realm Jumboways | 25 Desert Wealth | 46 20 Burning Hot Cash Heat |
| 7 Glorious Alexander Flaming Cash | 26 Burning Hot Epic Cash | 47 Totems of Riches Fury Cash |
| 8 Book of Realm Bonus Buy | 27 Book of Magic Dazzle Cash | 48 Exquisite Wealth Cash Heat |
| 9 The Great Exploit Shiny Cash | 28 Heroic Victory Epic Cash | 49 Pharaoh's Desert Cash Heat |
| 10 40 Super Hot Bonus Buy | 29 Great China Shiny Cash | 50 40 Super Power Bonus Buy |
| 11 Totems of Riches Fury Cash Flaming 4 Spins | 30 40 Burning Hot Bonus Buy | 51 Super Hot Jumboways |
| 12 Valhalla Thunderstorm | 31 Stars & Coins Respin | 52 Shining Crown Bonus Buy |
| 13 7x6 Mighty Heracle | 32 Vampire Night Flaming Cash | 53 Book of Flame |
| 14 Shining Booom | 33 Riches Touch | 54 Leprechaun Hot Bonus Buy |
| 15 Mighty Heracle | 34 Versailles Gold 6 Reels Bonus Buy | 55 Mystic Dawn Cash Heat |
| 16 20 Super Hot Epic Cash | 35 Sugartime | 56 Shining Crown Cash Heat |
| 17 20 Super Hot Dazzle Cash | 36 Versailles Gold Bonus Buy | 57 Tiki Fever Fury Cash |
| 18 Mighty Sparta Epic Cash | 37 Sea Wolf Riches Fury Cash | 58 Sands Spirit Cash Heat |
| 19 10 Shining Diamond Shiny Cash | 38 Olympus Glory Flaming Cash | |
| | 39 Eastern Carnival | |
| | 40 20 Super Power Bonus Buy | |

SUPREME



**RED
SELECTION**

Jackpots	Coin jackpot Jackpot Cards System Premium Link Jackpot System Lady's Card Jackpot System SAS-Progressive
Options & Features	Multi-denomination Autoplay Gamble Multi-language
Platform	EXCITER IV
SAS Protocol	SAS 6.03
Cabinets	G 50 C ST G 50 C UP G 50 J1 ST G 50 J1 UP G 50 J2 ST G 50 J2 UP G 27-27 ST G 27-27 UP G 27-32 ST G 27-32 UP G 50 V ST G 55 C VIP G 55 J1 VIP G 32-32 VIP GS 32-32 GS 32-32-32 PH 27-27 ST G 50-50 C VIP S 32-32 ST S 32-32 UP

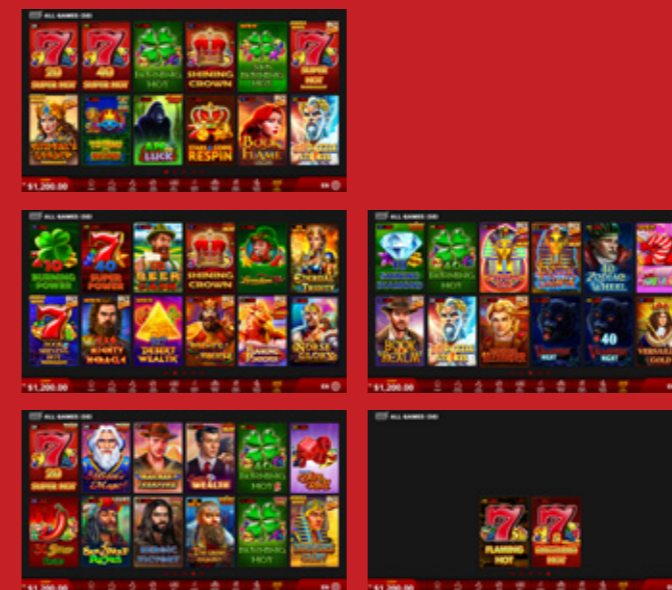

SUPREME

**RED
SELECTION**

new

- | | |
|---|---------------------------------|
| 1 20 Super Hot | 27 Shining Crown |
| 2 Athena's Legacy Jumboways | 28 Stars & Coins Respin |
| 3 10 Burning Power | 29 Shining Crown Cash Heat |
| 4 Book of Shining Hot Jumboways | 30 Riches Touch |
| 5 10 Shining Diamond Shiny Cash | 31 Mystic Dawn Cash Heat |
| 6 Book of Realm Bonus Buy | 32 Vampire Night |
| 7 20 Super Hot Dazzle Cash | 33 Exquisite Wealth Cash Heat |
| 8 30 Spicy Fruits | 34 The Great Exploit Shiny Cash |
| 9 Flaming Hot | 35 5x6 Burning Hot |
| 10 40 Super Hot | 36 Book of Flame |
| 11 Totems of Riches Fury Cash Flaming 4 Spins | 37 Leprechaun Hot |
| 12 40 Super Power | 38 Flaming Phoenix Flaming Cash |
| 13 7x6 Mighty Heracle | 39 40 Zodiac Wheel |
| 14 40 Burning Hot | 40 40 Vampire Night |
| 15 20 Dazzle Strikes | 41 40 Burning Hot 6 reels |
| 16 Book of Magic Dazzle Cash | 42 Burning Hot Epic Cash |
| 17 Sea Wolf Riches Fury Cash | 43 Super Hot Jumboways |
| 18 5 Dazzling Hot | 44 40 Dazzle Strikes |
| 19 Burning Hot | 45 Eternal Trinity |
| 20 Ape of Luck Flaming Cash | 46 Norse Glory |
| 21 10 Beer Cash | 47 Sugartime CAP |
| 22 6x7 Desert Wealth | 48 Versailles Gold Bonus Buy |
| 23 Egyptian Tale Cash Heat | 49 more Dice & Roll |
| 24 Glorious Alexander Flaming Cash | 50 Pharaoh's Glory Jumboways |
| 25 Karnak Treasure | |
| 26 Heroic Victory Epic Cash | |

SUPREME



**GREEN
SELECTION**

Jackpots	Coin jackpot Jackpot Cards System Premium Link Jackpot System Lady's Card Jackpot System SAS-Progressive
Options & Features	Multi-denomination Autoplay Gamble Multi-language
Platform	EXCITER IV
SAS Protocol	SAS 6.03
Cabinets	G 50 C ST G 50 C UP G 50 J1 ST G 50 J1 UP G 50 J2 ST G 50 J2 UP G 27-27 ST G 27-27 UP G 27-32 ST G 27-32 UP G 50 V ST G 55 C VIP G 55 J1 VIP G 32-32 VIP GS 32-32 GS 32-32-32 PH 27-27 ST G 50-50 C VIP S 32-32 ST S 32-32 UP

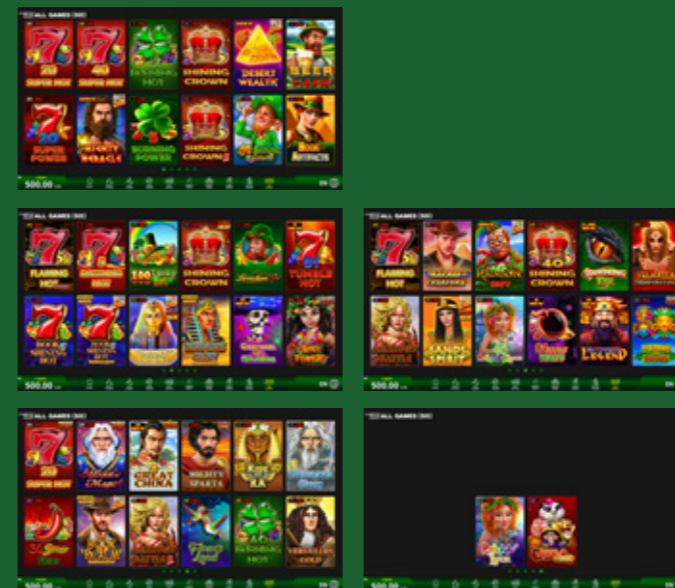

SUPREME

**GREEN
SELECTION**

new

- | | |
|----------------------------------|----------------------------|
| 1 20 super hot | 26 Karnak treasure |
| 2 40 super hot | 27 Rainbow hot |
| 3 Burning hot | 28 40 Shining crown |
| 4 Shining crown | 29 Burning eye |
| 5 Desert wealth | 30 Valhalla Thunderstorm |
| 6 Beer cash | 31 Amazon`s battle |
| 7 20 super power | 32 Sands spirit |
| 8 Mighty heracle | 33 40 Rainbow luck |
| 9 5 burning power | 34 81 Fruit ways |
| 10 Shining crown 6 reels | 35 Prosperity Legend |
| 11 40 Shining rainbow | 36 Totems of riches |
| 12 Book of artifacts | 37 20 Super hot |
| 13 Flaming hot Extreme | 38 Book of magic |
| 14 5 dazzling hot | 39 Great China |
| 15 100 Lucky hat | 40 Mighty Sparta |
| 16 Shining crown | 41 Rise of Ra |
| 17 Leprechaun hot | 42 Olympus Glory |
| 18 81 Tumble Hot | 43 30 Spicy fruits |
| 19 Book of Shining Hot | 44 Book of Realm Jumboways |
| 20 Book of Shining Hot Jumboways | 45 Amazon`s battle 6 reels |
| 21 Pharaoh`s desert | 46 Flower land |
| 22 Pharaoh`s Glory Jumboways | 47 40 Burning hot |
| 23 Carnaval de la calavera | 48 Versailles Gold |
| 24 Tiki Fever | 49 Rainbow luck |
| 25 Flaming hot | 50 China food |

MEGA SUPREME
FRUITS SELECTION

Jackpots	Coin jackpot Jackpot Cards System Premium Link Jackpot System Lady's Card Jackpot System SAS-Progressive
Options & Features	Multi-denomination Autoplay Gamble Multi-language
Platform	EXCITER IV
SAS Protocol	SAS 6.03
Cabinets	G 50 C ST G 50 C UP G 50 J1 ST G 50 J1 UP G 50 J2 ST G 50 J2 UP G 27-27 ST G 27-27 UP G 27-32 ST G 27-32 UP G 50 V ST G 55 C VIP G 55 J1 VIP G 32-32 VIP GS 32-32 GS 32-32-32 PH 27-27 ST G 50-50 C VIP S 32-32 ST S 32-32 UP

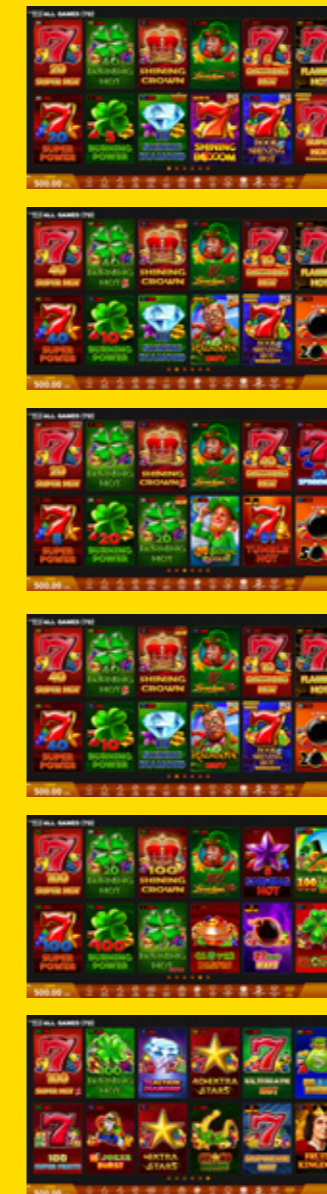

MEGA SUPREME
FRUITS SELECTION new

- | | | |
|-------------------------------------|-------------------------------------|------------------------|
| 1 20 Super Hot | 27 Shining Crown
Cash Heat | 53 40 Dazzling Hot |
| 2 20 Super Power | 28 10 Shining Diamond | 54 81 Tumble Hot |
| 3 40 Super Hot | 29 Shining Crown 6 Reels | 55 100 Dazzling Hot |
| 4 40 Super Power | 30 20 Burning Hot
Cash Heat | 56 81 Fruit Ways |
| 5 20 Super Hot
Epic Cash | 31 40 Shining Crown | 57 5 Shining Hot |
| 6 5 Super Power | 32 Burning Hot 6 Reels | 58 27 Fruit Ways |
| 7 20 Super Hot
Dazzle Cash | 33 100 Shining Crown | 59 Ultimate Hot |
| 8 10 Super Power | 34 Burning Hot Extreme | 60 Supreme Hot |
| 9 100 Super Hot | 35 10 Action Diamond | 61 Flaming Hot Extreme |
| 10 100 Super Power | 36 Extra Stars | 62 Super Hot Jumboways |
| 11 100 Super Hot 6 Reels | 37 Leprechaun Hot | 63 Flaming Hot |
| 12 100 Super Fruits | 38 Shining Boom | 64 20 Hot Blast |
| 13 40 Burning Hot | 39 10 Leprechaun Hot | 65 30 Spinning 7's |
| 14 5 Burning Power | 40 Rainbow Hot | 66 50 Hot Blast |
| 15 40 Burning Hot 6 reels | 41 20 Leprechaun Hot | 67 30 Spicy Fruits |
| 16 10 Burning Power | 42 40 Shining Rainbow | 68 40 Mega Clover |
| 17 Burning Hot Epic Cash | 43 40 Leprechaun Hot | 69 100 Lucky Hat |
| 18 20 Burning Power | 44 20 Shining Rainbow | 70 50 Mega Clover |
| 19 Burning Hot | 45 100 Leprechaun Hot | 71 40 Ultra Respin |
| 20 40 Burning Power | 46 Clover Respin | 72 Fruits Kingdom |
| 21 20 Burning Hot | 47 40 Extra Stars | |
| 22 100 Burning Power | 48 Stars Respin | |
| 23 100 Burning Hot | 49 5 Dazzling Hot | |
| 24 10 Joker Burst | 50 Book of Shining Hot
Bonus Buy | |
| 25 Shining Crown | 51 10 Dazzling Hot | |
| 26 10 Shining Diamond
Shiny Cash | 52 Book of Shining Hot
Jumboways | |

Jackpots	Coin jackpot Jackpot Cards System Premium Link Jackpot System Lady's Card Jackpot System Diamond Number
Options & Features	Autoplay Multi-language Limit Scheduler Remote counters
Platform	
SAS Protocol	SAS 6.03
Cabinets	G 32 T G 27 T GS 32 T S 32-32 ST S 32-32 UP

SUPREME new

ROULETTE UNION

- 1 Automatic Panorama Roulette Single Zero
- 2 Automatic Panorama Roulette Double Zero
- 3 Virtual Panorama Roulette Single Zero
- 4 Virtual Panorama Roulette Double Zero



Jackpots	Coin jackpot Jackpot Cards System Premium Link Jackpot System Lady's Card Jackpot System Diamond Number
Options & Features	Autoplay Multi-language Limit Scheduler Remote counters
Platform	
SAS Protocol	SAS 6.03
Cabinets	G 32 T G 27 T GS 32 T S 32-32 ST S 32-32 UP

SUPREME new

GREEN UNION

- 1-4 Roulette
 - Layout: Panorama & Classic
 - Type: European & American
 - Server: Automatic, Virtual & Live
- 5 Extra Star Blackjack
- 6 Star Blackjack
- 7 Baccarat
- 8 Keno Universe
- 9 Dragon & Tiger
- 10 40 Super Hot
- 11 Burning Hot
- 12 Shining Crown
- 13 20 Super Hot
- 14 Flaming Hot Extreme
- 15 20 Super Power
- 16 Vampire Night
- 17 40 Burning Hot
- 18 Desert Wealth
- 19 Burning Hot Epic Cash
- 20 Exquisite Wealth Cash Heat
- 21 Totems of Riches Fury Cash;
- 22 20 Super Hot Dazzle Cash
- 23 10 Shining Diamond Shiny Cash
- 24 The Great Exploit Shiny Cash
- 25 5 Dazzling Hot
- 26 5 Burning Power
- 27 100 Super Hot
- 28 40 Burning hot 6 reels
- 29 40 shining crown

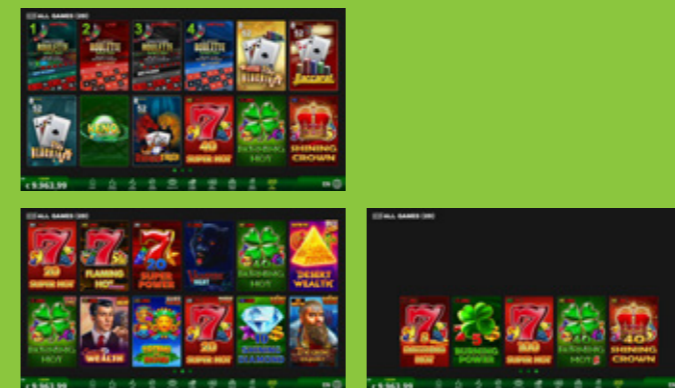



GOLD HD GENERAL

Jackpots	Coin jackpot Jackpot Cards System Premium Link Jackpot System Lady's Card Jackpot System SAS-Progressive
Options & Features	Multi-denomination Autoplay Gamble Multi-language
Platform	EXCITER IV
SAS Protocol	SAS 6.02
Cabinets	G 50 C ST G 50 C UP G 50 J1 ST G 50 J1 UP G 50 J2 ST G 50 J2 UP G 27-27 ST G 27-27 UP G 27-32 ST G 27-32 UP G 50 V ST G 55 C VIP G 55 J1 VIP G 50-50 C VIP G 32-32 VIP S 32-32 UP S 32-32 ST

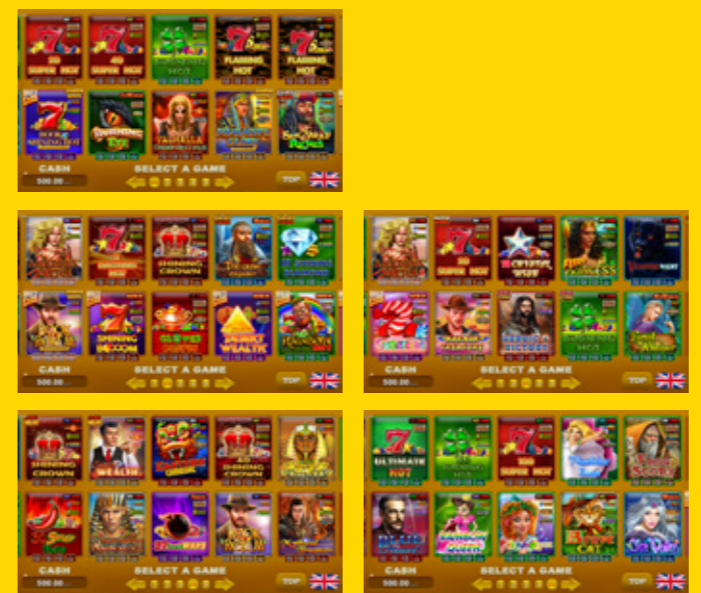

GOLD HD GENERAL

- | | |
|----------------------------------|-------------------------------|
| 1 20 Super Hot | 25 Vampire Night |
| 2 40 Super Hot | 26 Sugartime |
| 3 Burning Hot | 27 Karnak Treasure |
| 4 Flaming Hot | 28 Heroic Victory Epic Cash |
| 5 Flaming Hot Extreme | 29 Burning Hot Epic Cash |
| 6 Book of Shining Hot Jumboways | 30 Forest Whisper |
| 7 Burning Eye | 31 Shining Crown Cash Heat |
| 8 Valhalla Thunderstorm | 32 Exquisite Wealth Cash Heat |
| 9 Pharaoh's Glory Jumboways | 33 Eastern Carnival |
| 10 Sea Wolf Riches Fury Cash | 34 40 Shining Crown |
| 11 Amazons' Battle | 35 Rise of Ra |
| 12 5 Dazzling Hot | 36 30 Spicy Fruits |
| 13 Shining Crown | 37 Almighty Ramses II |
| 14 The Great Exploit Shiny Cash | 38 27 Fruit Ways |
| 15 10 Shining Diamond Shiny Cash | 39 Book of Realm |
| 16 Book of Realm Jumboways | 40 Mythical Treasure |
| 17 Shining Boom | 41 Ultimate Hot |
| 18 Clover Respin | 42 40 Burning Hot |
| 19 Desert Wealth | 43 100 Super Hot |
| 20 Rainbow Hot | 44 Thumbelina's Dream |
| 21 Amazons' Battle 6 reels | 45 Frog Story |
| 22 20 Super Hot Dazzle Cash | 46 Blue Heart |
| 23 10 Crystal Wish | 47 Rainbow Queen |
| 24 Fury Princess | 48 Rainbow Luck |
| | 49 Brave Cat |
| | 50 Ice Valley |



BLUE HD GENERAL

Jackpots	Coin jackpot Jackpot Cards System Premium Link Jackpot System Lady's Card Jackpot System SAS-Progressive
Options & Features	Multi-denomination Autoplay Gamble Multi-language
Platform	EXCITER IV
SAS Protocol	SAS 6.02
Cabinets	G 50 C ST G 50 C UP G 50 J1 ST G 50 J1 UP G 50 J2 ST G 50 J2 UP G 27-27 ST G 27-27 UP G 27-32 ST G 27-32 UP G 50 V ST G 55 C VIP G 55 J1 VIP G 50-50 C VIP G 32-32 VIP S 32-32 UP S 32-32 ST

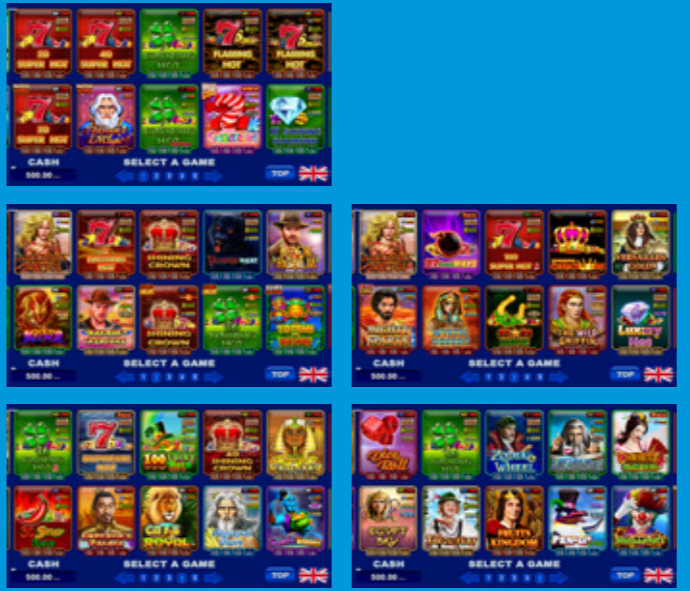

BLUE HD GENERAL

- 1 20 Super Hot
- 2 40 Super Hot
- 3 Burning Hot
- 4 Flaming Hot
- 5 Flaming Hot Extreme
- 6 20 Super Hot Dazzle Cash
- 7 Book of Magic Dazzle Cash
- 8 Burning Hot Extreme
- 9 Sugartime
- 10 10 Shining Diamond
- 11 Amazons' Battle
- 12 5 Dazzling Hot
- 13 Shining Crown
- 14 Vampire Night
- 15 Book of Realm
- 16 Gold Keeper
- 17 Karnak Treasure
- 18 Shining Crown Cash Heat
- 19 20 Burning Hot Cash Heat
- 20 Totems of Riches
- 21 Amazons' Battle 6 reels
- 22 27 Fruit Ways
- 23 100 Super Hot 6 reels
- 24 Spinning Crown
- 25 Versailles Gold
- 26 Mighty Sparta Epic Cash
- 27 Mystic Desert
- 28 Stars Respin
- 29 The Wild Griffin
- 30 Luxury Hot
- 31 40 Burning Hot 6 reels
- 32 Supreme Hot
- 33 100 Lucky Hat
- 34 40 Shining Crown
- 35 Rise of Ra
- 36 30 Spicy Fruits
- 37 Emperor's Palace
- 38 Cats Royal
- 39 Olympus Glory
- 40 Genie's Temple
- 41 Dice & Roll
- 42 40 Burning Hot
- 43 Zodiac Wheel
- 44 Secrets of Alchemy
- 45 Chinese Garden
- 46 Egypt Sky
- 47 Tirol Fest
- 48 Fruits Kingdom
- 49 Penguin Style
- 50 Circus Brilliant



Jackpots	Coin jackpot Jackpot Cards System Premium Link Jackpot System Lady's Card Jackpot System SAS-Progressive
Options & Features	Multi-denomination Autoplay Gamble Multi-language
Platform	EXCITER IV [®]
SAS Protocol	SAS 6.02
Cabinets	G 50 C ST G 50 C UP G 50 J1 ST G 50 J1 UP G 50 J2 ST G 50 J2 UP G 27-27 ST G 27-27 UP G 27-32 ST G 27-32 UP G 50 V ST G 55 C VIP G 55 J1 VIP G 50-50 C VIP G 32-32 VIP S 32-32 UP S 32-32 ST

BONUS PRIZE HD GENERAL

- 1 20 Super Hot Epic Cash
- 2 Mighty Sparta Epic Cash
- 3 Exquiste Wealth Cash Heat
- 4 Book of Magic Dazzle Cash
- 5 10 Shining Diamond Shiny Cash
- 6 Shining Crown Cash Heat
- 7 Totems of Riches Fury Cash
- 8 Burning Hot Epic Cash
- 9 Heroic Victory Epic Cash
- 10 Eastern Carnival
- 11 The Great Exploit Shiny Cash
- 12 20 Super Hot Dazzle Cash
- 13 20 Burning Hot Cash heat
- 14 Great China Shiny Cash

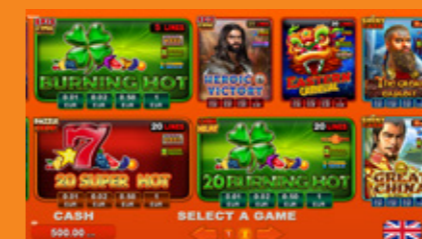
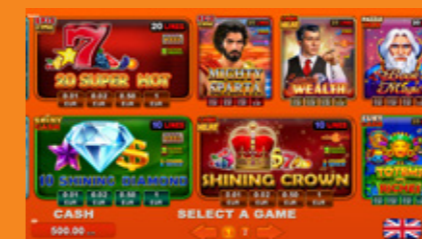

Jackpots	Coin jackpot Jackpot Cards System Premium Link Jackpot System Lady's Card Jackpot System SAS-Progressive
Options & Features	Multi-denomination Autoplay Gamble Multi-language
Platform	
SAS Protocol	SAS 6.02
Cabinets	G 50 C ST G 50 C UP G 50 J1 ST G 50 J1 UP G 50 J2 ST G 50 J2 UP G 27-27 ST G 27-27 UP G 27-32 ST G 27-32 UP G 50 V ST G 55 C VIP G 55 J1 VIP G 50-50 C VIP G 32-32 VIP S 32-32 UP S 32-32 ST

GREEN HD GENERAL

- | | |
|---------------------------------|---------------------------|
| 1 20 Super Hot | 30 Almighty Realm |
| 2 40 Super Hot | 31 40 Burning Hot 6 Reels |
| 3 Burning Hot | 32 Burning Hot 6 Reels |
| 4 Flaming Hot | 33 100 Lucky Hat |
| 5 Flaming Hot Extreme | 34 40 Shining Crown |
| 6 20 Super Hot Epic Cash | 35 Rise of Ra |
| 7 Fury Princess | 36 30 Spicy Fruits |
| 8 Burning Hot Epic Cash | 37 Emperor's Palace |
| 9 Eastern Carnival | 38 Retro Cabaret |
| 10 Shining Grace | 39 Lucky Food |
| 11 Amazons' Battle | 40 Mythical Treasure |
| 12 5 Dazzling Hot | 41 Extra Stars |
| 13 Shining Crown | 42 40 Burning Hot |
| 14 10 Joker Burst | 43 100 Super Hot |
| 15 10 Crystal Wish | 44 20 Hot Blast |
| 16 Heroic Victory Epic Cash | 45 Volcano Wealth |
| 17 Forest Whisper | 46 Knights Heart |
| 18 Vampire Night | 47 Tirol Fest |
| 19 Wealth Palace | 48 Rainbow Luck |
| 20 Cats' Story | 49 Lucky Wood |
| 21 Amazons' Battle 6 Reels | 50 Ice Valley |
| 22 Retro Cabaret 6 Reels | |
| 23 Flaming Hot 6 Reels | |
| 24 40 Charming Joker | |
| 25 Versailles Gold | |
| 26 Mighty Sparta Epic Cash | |
| 27 The Great Exploit Shiny Cash | |
| 28 Tropical Beauties | |
| 29 Irish Charm | |

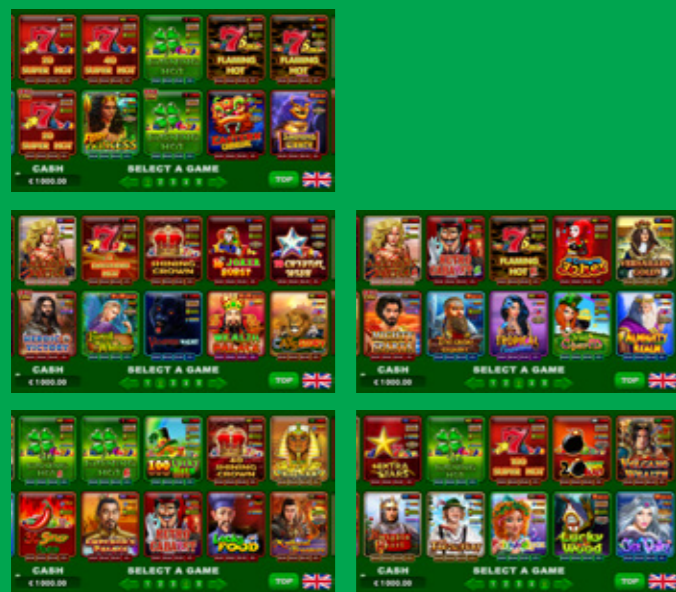

Jackpots	Coin jackpot Jackpot Cards System Premium Link Jackpot System Lady's Card Jackpot System SAS-Progressive
Options & Features	Multi-denomination Autoplay Gamble Multi-language
Platform	
SAS Protocol	SAS 6.02
Cabinets	G 50 C ST G 50 C UP G 50 J1 ST G 50 J1 UP G 50 J2 ST G 50 J2 UP G 27-27 ST G 27-27 UP G 27-32 ST G 27-32 UP G 50 V ST G 55 C VIP G 55 J1 VIP G 32-32 VIP S 32-32 ST S 32-32 UP

FRUITS HD GENERAL

- | | |
|---------------------------|----------------------|
| 1 20 Super Hot | 30 50 Hot Blast |
| 2 40 Super Hot | 31 Fruits Kingdom |
| 3 Burning Hot | 32 Dice & Roll |
| 4 Flaming Hot | 33 Lucky & Wild |
| 5 Flaming Hot Extreme | 34 Hot & Cash |
| 6 Leprechaun Hot | 35 10 Burning Heart |
| 7 5 Dazzling Hot | 36 40 Ultra Respin |
| 8 40 Burning Hot | 37 more Dice & Roll |
| 9 Shining Crown | 38 more Lucky & Wild |
| 10 40 Shining Crown | 39 40 Hot & Cash |
| 11 100 Lucky Hat | 40 Caramel Hot |
| 12 100 Super Hot | 41 27 Wins |
| 13 100 Flaming Hot | 42 81 Wins |
| 14 100 Burning Hot | 43 Great 27 |
| 15 100 Super Fruits | 44 Supreme Hot |
| 16 Burning Hot 6 reels | 45 Lucky Hot |
| 17 40 Burning Hot 6 reels | 46 Extremely Hot |
| 18 Flaming Hot 6 reels | 47 Ultimate Hot |
| 19 30 Spicy Fruits | 48 5 Juggle Fruits |
| 20 20 Hot Blast | 49 40 Extra Stars |
| 21 20 Burning Hot | 50 50 Mega Clover |
| 22 20 Joker Reels | |
| 23 20 Dazzling Hot | |
| 24 20 Charming Joker | |
| 25 Extra Stars | |
| 26 40 Lucky King | |
| 27 40 Joker Reels | |
| 28 40 Mega Clover | |
| 29 50 Spicy Fruits | |



RED HD GENERAL

- 1 20 Super Hot
- 2 40 Super Hot
- 3 Burning Hot
- 4 Flaming Hot
- 5 Flaming Hot 6 reels
- 6 Amazons' Battle 6 reels
- 7 Great China Shiny Cash
- 8 Mighty Sparta Epic Cash
- 9 Chinese Garden
- 10 Leprechaun Hot
- 11 Amazons' Battle
- 12 5 Dazzling Hot
- 13 Shining Crown
- 14 Versailles Gold
- 15 Rise of Ra
- 16 40 Burning Hot
- 17 Flower Land
- 18 Lucky Food
- 19 China Food
- 20 Irish Charm
- 21 100 Super Fruits
- 22 100 Burning Hot
- 23 100 Super Hot
- 24 100 Flaming Hot
- 25 30 Spicy Fruits
- 26 Golden Eternity
- 27 Gangster's Cash
- 28 Emperor's Dream
- 29 Amazing China
- 30 Genie's Temple
- 31 20 Hot Blast
- 32 Tirol Fest
- 33 Emperor's Palace
- 34 Frog Story
- 35 Almighty Ramses II
- 36 Sweetie Dogs
- 37 Eastern Legends
- 38 El Amigo
- 39 Glorious Hidalgo
- 40 Almighty Ramses II both ways
- 41 40 Lucky King
- 42 Eternal Lotus
- 43 20 Dazzling Hot
- 44 Irish Treasure
- 45 The Story of Alexander
- 46 20 Burning Hot
- 47 20 Joker Reels
- 48 40 Mega Clover
- 49 more Dice & Roll
- 50 Age of Troy

Jackpots	Coin jackpot Jackpot Cards System Premium Link Jackpot System Lady's Card Jackpot System SAS-Progressive
Options & Features	Multi-denomination Autoplay Gamble Multi-language
Platform	EXCITER III [®] EXCITER IV [®]
SAS Protocol	SAS 6.02
Cabinets	G 50 C ST G 50 C UP G 50 J1 ST G 50 J1 UP G 50 J2 ST G 50 J2 UP G 27-27 ST G 27-27 UP G 27-32 ST G 27-32 UP G 50 V ST G 55 C VIP G 55 J1 VIP G 32-32 VIP S 32-32 ST S 32-32 UP

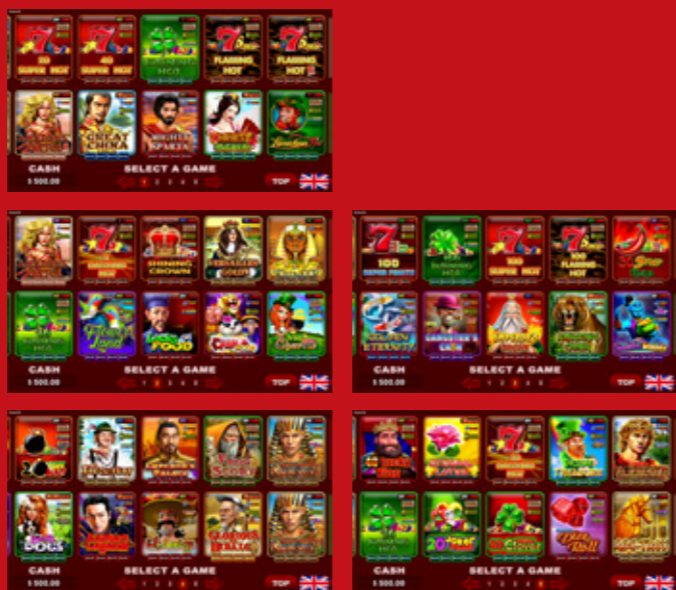

SERIES GENERAL





GOLD HD GENERAL BLUE HD GENERAL BONUS PRIZE HD GENERAL
 GREEN HD GENERAL FRUITS HD GENERAL RED HD GENERAL

Jackpots	Coin jackpot Jackpot Cards System Premium Link Jackpot System Lady's Card Jackpot System SAS-Progressive
Options & Features	Multi-denomination Autoplay Gamble Multi-language
Platform	
SAS Protocol	SAS 6.02
Cabinets	G 50 C ST G 50 C UP G 50 J1 ST G 50 J1 UP G 50 J2 ST G 50 J2 UP G 27-27 ST G 27-27 UP G 27-32 ST G 27-32 UP G 50 V ST G 55 C VIP G 55 J1 VIP G 50-50 C VIP G 32-32 VIP S 32-32 UP S 32-32 ST

WINNER SELECTION 1

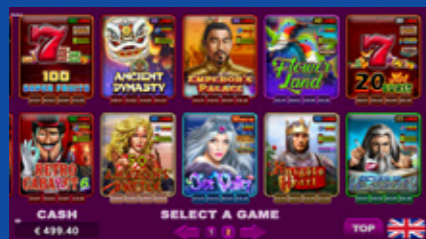
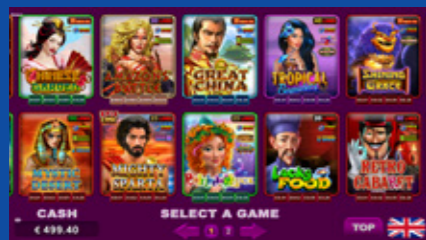
- Chinese Garden
- Amazons' Battle
- Great China Shiny Cash
- Tropical Beauties
- Shining Grace
- Mystic Desert
- Mighty Sparta Epic Cash
- Rainbow Luck
- Lucky Food
- Retro Cabaret
- 100 Super Fruits
- Ancient Dynasty
- Emperor's Palace
- Flower Land
- 20 Hot Burst
- Retro Cabaret 6 reels
- 50 Amazons' Battle
- Ice Valley
- Knights Heart
- Secrets of Alchemy



Jackpots	Coin jackpot Jackpot Cards System Premium Link Jackpot System Lady's Card Jackpot System SAS-Progressive
Options & Features	Multi-denomination Autoplay Gamble Multi-language
Platform	
SAS Protocol	SAS 6.02
Cabinets	G 50 C ST G 50 C UP G 50 J1 ST G 50 J1 UP G 50 J2 ST G 50 J2 UP G 27-27 ST G 27-27 UP G 27-32 ST G 27-32 UP G 50 V ST G 55 C VIP G 55 J1 VIP G 50-50 C VIP G 32-32 VIP S 32-32 UP S 32-32 ST

WINNER SELECTION 2

- Vampire King
- Volcano Wealth
- Amazons' Battle
- Almighty Realm
- Eastern Carnival
- The Wild Griffin
- Heroic Victory Epic Cash
- The Great Exploit Shiny Cash
- Chinese Garden
- Gangster's Cash
- Amazons' Battle 6 reels
- Mythical Treasure
- Dorothy's Fairyland
- 30 Spinning 7's
- Action Money
- Tirol Fest
- China Food
- Genie's Temple
- Penguin Style
- 10 Action Diamond

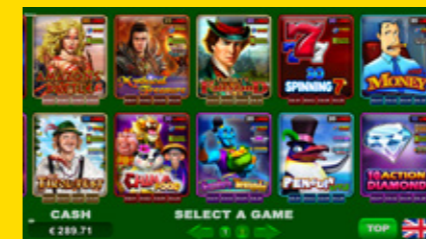
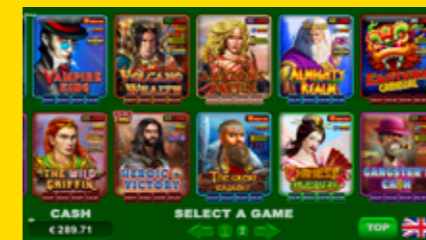

Jackpots	Coin jackpot Jackpot Cards System Premium Link Jackpot System Lady's Card Jackpot System SAS-Progressive
Options & Features	Multi-denomination Autoplay Gamble Multi-language
Platform	
SAS Protocol	SAS 6.02
Cabinets	G 50 C ST G 50 C UP G 50 J1 ST G 50 J1 UP G 50 J2 ST G 50 J2 UP G 27-27 ST G 27-27 UP G 27-32 ST G 27-32 UP G 50 V ST G 55 C VIP G 55 J1 VIP G 50-50 C VIP G 32-32 VIP S 32-32 UP S 32-32 ST

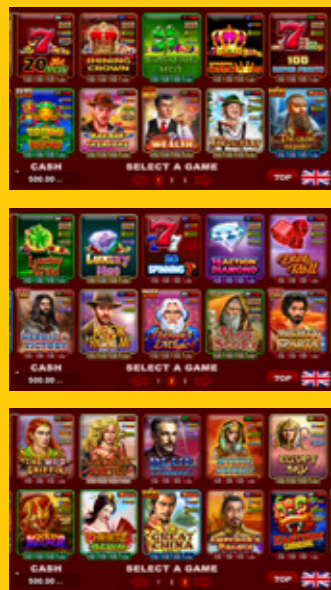

WINNER SELECTION 3

- | | | | |
|----|------------------------------|----|---------------------------|
| 1 | 20 Hot Burst | 16 | Heroic Victory Epic Cash |
| 2 | Shining Crown | 17 | Book Of Realm |
| 3 | Burning Hot | 18 | Book Of Magic Dazzle Cash |
| 4 | Spinning Crown | 19 | Frog Story |
| 5 | 100 Super Fruits | 20 | Mighty Sparta Epic Cash |
| 6 | Totems Of Riches Fury Cash | 21 | The Wild Griffin |
| 7 | Karnak Treasure | 22 | Amazons` Battle 6 Reels |
| 8 | Exquisite Wealth Cash Heat | 23 | Blue Heart |
| 9 | Tirol Fest | 24 | Mystic Desert |
| 10 | The Great Exploit Shiny Cash | 25 | Egypt Sky |
| 11 | Lucky & Wild | 26 | Gold Keeper |
| 12 | Luxury Hot | 27 | Chinese Garden |
| 13 | 30 Spinning 7`s | 28 | Great China Shiny Cash |
| 14 | 10 Action Diamond | 29 | Emperor`s Palace |
| 15 | Dice & Roll | 30 | Eastern Carnival |

Jackpots	Coin jackpot Jackpot Cards System Premium Link Jackpot System Lady's Card Jackpot System SAS-Progressive
Options & Features	Multi-denomination Autoplay Gamble Multi-language
Platform	
SAS Protocol	SAS 6.02
Cabinets	G 50 C ST G 50 C UP G 50 J1 ST G 50 J1 UP G 50 J2 ST G 50 J2 UP G 27-27 ST G 27-27 UP G 27-32 ST G 27-32 UP G 50 V ST G 55 C VIP G 55 J1 VIP G 50-50 C VIP G 32-32 VIP S 32-32 UP S 32-32 ST

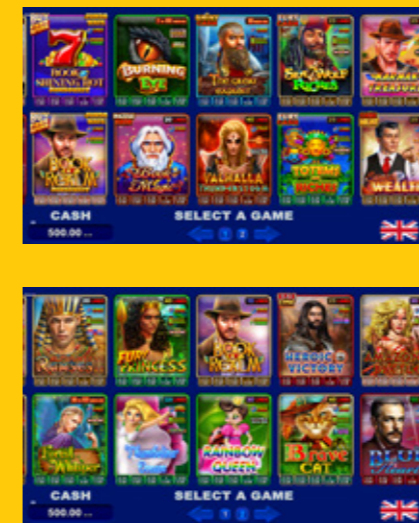

WINNER SELECTION 4

- 1 Book of Shining Hot Jumboways
- 2 Burning Eye
- 3 The Great Exploit
- 4 Sea Wolf Riches Fury Cash
- 5 Karnak Treasure
- 6 Book of Realm Jumboways
- 7 Book of Magic Dazzle Cash
- 8 Valhalla Thunderstorm
- 9 Totem of Riches
- 10 Exquisite Wealth Cash Heat
- 11 Almighty Ramses II
- 12 Fury Princess
- 13 Book of Realm
- 14 Heroic Victory Epic Cash
- 15 Amazons' Battle
- 16 Forest Whisper
- 17 Thumbelina's Dream
- 18 Rainbow Queen
- 19 Brave Cat
- 20 Blue Heart

Jackpots	Coin jackpot Jackpot Cards System Premium Link Jackpot System Lady's Card Jackpot System SAS-Progressive																																	
Options & Features	Multi-denomination Autoplay Gamble Multi-language																																	
Platform																																		
SAS Protocol	SAS 6.02																																	
Cabinets	<table border="0"> <tr><td>G 50 C ST</td><td> </td><td>G 50 C UP</td></tr> <tr><td>G 50 J1 ST</td><td> </td><td>G 50 J1 UP</td></tr> <tr><td>G 50 J2 ST</td><td> </td><td>G 50 J2 UP</td></tr> <tr><td>G 27-27 ST</td><td> </td><td>G 27-27 UP</td></tr> <tr><td>G 27-32 ST</td><td> </td><td>G 27-32 UP</td></tr> <tr><td>G 50 V ST</td><td> </td><td>G 55 C VIP</td></tr> <tr><td>G 55 J1 VIP</td><td> </td><td>G 50-50 C VIP</td></tr> <tr><td>G 32-32 VIP</td><td> </td><td>G 27 T</td></tr> <tr><td>G 32 T</td><td> </td><td>GS 32 T</td></tr> <tr><td>GS 32-32</td><td> </td><td>GS 32-32-32</td></tr> <tr><td>S 32-32 ST</td><td> </td><td>S 32-32 UP</td></tr> </table>	G 50 C ST		G 50 C UP	G 50 J1 ST		G 50 J1 UP	G 50 J2 ST		G 50 J2 UP	G 27-27 ST		G 27-27 UP	G 27-32 ST		G 27-32 UP	G 50 V ST		G 55 C VIP	G 55 J1 VIP		G 50-50 C VIP	G 32-32 VIP		G 27 T	G 32 T		GS 32 T	GS 32-32		GS 32-32-32	S 32-32 ST		S 32-32 UP
G 50 C ST		G 50 C UP																																
G 50 J1 ST		G 50 J1 UP																																
G 50 J2 ST		G 50 J2 UP																																
G 27-27 ST		G 27-27 UP																																
G 27-32 ST		G 27-32 UP																																
G 50 V ST		G 55 C VIP																																
G 55 J1 VIP		G 50-50 C VIP																																
G 32-32 VIP		G 27 T																																
G 32 T		GS 32 T																																
GS 32-32		GS 32-32-32																																
S 32-32 ST		S 32-32 UP																																

BLUE HD POWER

- | | | | |
|-----|--|----|--------------------------|
| 1 | Star Blackjack | 26 | 20 Burning Hot Cash Heat |
| 2 | Baccarat | 27 | Totems of Riches |
| 3 | Extra Star Blackjack | 28 | Amazons' Battle 6 reels |
| 4 | Keno Universe | 29 | 27 Fruit Ways |
| 5 | 20 Super Hot | 30 | 100 Super Hot 6 reels |
| 6-8 | European Roulette
- Automatic
(Resizable Stream)
- Automatic
(Full Screen Stream)
- Stand-alone | 31 | Spinning Crown |
| | American Roulette
- Automatic
(Resizable Stream)
- Automatic
(Full Screen Stream)
- Stand-alone | 32 | Versailles Gold |
| 9 | 40 Super Hot | 33 | Mighty Sparta Epic Cash |
| 10 | Burning Hot | 34 | Mystic Desert |
| 11 | Flaming Hot | 35 | Stars Respin |
| 12 | Flaming Hot Extreme | 36 | The Wild Griffin |
| 13 | 20 Super Hot Dazzle Cash | 37 | Luxury Hot |
| 14 | Book of Magic Dazzle Cash | 38 | 40 Burning Hot 6 reels |
| 15 | Burning Hot Extreme | 39 | Supreme Hot |
| 16 | Sugartime | 40 | 100 Lucky Hat |
| 17 | 10 Shining Diamond | 41 | 40 Shining Crown |
| 18 | Amazons' Battle | 42 | Rise of Ra |
| 19 | 5 Dazzling Hot | 43 | 30 Spicy Fruits |
| 20 | Shining Crown | 44 | Emperor's Palace |
| 21 | Vampire Night | 45 | Cats Royal |
| 22 | Book of Realm | 46 | Olympus Glory |
| 23 | Gold Keeper | 47 | Genie's Temple |
| 24 | Karnak Treasure | 48 | Dice & Roll |
| 25 | Shining Crown Cash Heat | 49 | 40 Burning Hot |
| | | 50 | Zodiac Wheel |
| | | 51 | Secrets of Alchemy |
| | | 52 | Chinese Garden |
| | | 53 | Egypt Sky |
| | | 54 | Tirol Fest |
| | | 55 | Fruits Kingdom |
| | | 56 | Penguin Style |
| | | 57 | Circus Brilliant |

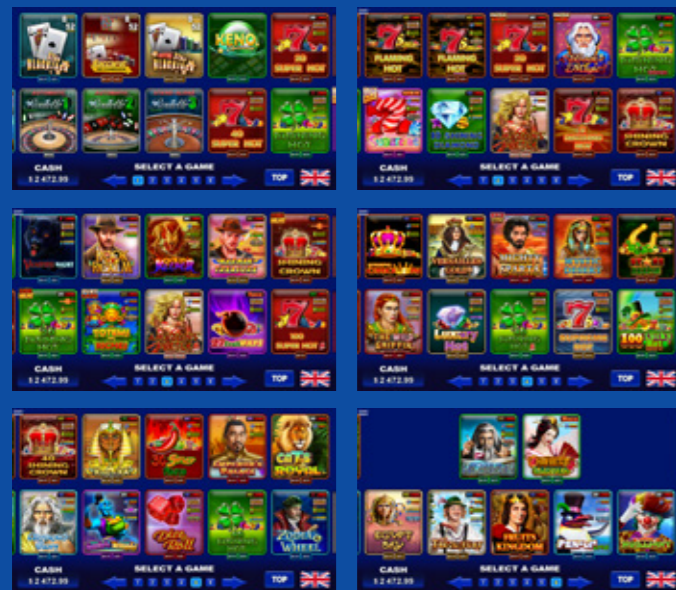

Jackpots	Coin jackpot Jackpot Cards System Premium Link Jackpot System Lady's Card Jackpot System SAS-Progressive																																	
Options & Features	Multi-denomination Autoplay Gamble Multi-language																																	
Platform																																		
SAS Protocol	SAS 6.02																																	
Cabinets	<table border="0"> <tr><td>G 50 C ST</td><td> </td><td>G 50 C UP</td></tr> <tr><td>G 50 J1 ST</td><td> </td><td>G 50 J1 UP</td></tr> <tr><td>G 50 J2 ST</td><td> </td><td>G 50 J2 UP</td></tr> <tr><td>G 27-27 ST</td><td> </td><td>G 27-27 UP</td></tr> <tr><td>G 27-32 ST</td><td> </td><td>G 27-32 UP</td></tr> <tr><td>G 50 V ST</td><td> </td><td>G 55 C VIP</td></tr> <tr><td>G 55 J1 VIP</td><td> </td><td>G 50-50 C VIP</td></tr> <tr><td>G 32-32 VIP</td><td> </td><td>G 27 T</td></tr> <tr><td>G 32 T</td><td> </td><td>GS 32 T</td></tr> <tr><td>GS 32-32</td><td> </td><td>GS 32-32-32</td></tr> <tr><td>S 32-32 ST</td><td> </td><td>S 32-32 UP</td></tr> </table>	G 50 C ST		G 50 C UP	G 50 J1 ST		G 50 J1 UP	G 50 J2 ST		G 50 J2 UP	G 27-27 ST		G 27-27 UP	G 27-32 ST		G 27-32 UP	G 50 V ST		G 55 C VIP	G 55 J1 VIP		G 50-50 C VIP	G 32-32 VIP		G 27 T	G 32 T		GS 32 T	GS 32-32		GS 32-32-32	S 32-32 ST		S 32-32 UP
G 50 C ST		G 50 C UP																																
G 50 J1 ST		G 50 J1 UP																																
G 50 J2 ST		G 50 J2 UP																																
G 27-27 ST		G 27-27 UP																																
G 27-32 ST		G 27-32 UP																																
G 50 V ST		G 55 C VIP																																
G 55 J1 VIP		G 50-50 C VIP																																
G 32-32 VIP		G 27 T																																
G 32 T		GS 32 T																																
GS 32-32		GS 32-32-32																																
S 32-32 ST		S 32-32 UP																																

GREEN HD POWER

- | | | | |
|-----|--|----|------------------------------|
| 1 | Star Blackjack | 27 | Tropical Beauties |
| 2 | Baccarat | 28 | Heroic Victory Epic Cash |
| 3 | Extra Star Blackjack | 29 | Forest Whisper |
| 4 | Keno Universe | 30 | Vampire Night |
| 5 | 20 Super Hot | 31 | 40 Charming Joker |
| 6-8 | European Roulette
- Automatic
(Resizable Stream)
- Automatic
(Full Screen Stream)
- Stand-alone | 32 | Versailles Gold |
| | American Roulette
- Automatic
(Resizable Stream)
- Automatic
(Full Screen Stream)
- Stand-alone | 33 | 100 Lucky Hat |
| 9 | 40 Super Hot | 34 | 40 Shining Crown |
| 10 | Burning Hot | 35 | Rise of Ra |
| 11 | Flaming Hot | 36 | Wealth Palace |
| 12 | Flaming Hot Extreme | 37 | Cats' Story |
| 13 | Amazons' Battle | 38 | Mighty Sparta Epic Cash |
| 14 | 5 Dazzling Hot | 39 | The Great Exploit Shiny Cash |
| 15 | Shining Crown | 40 | Shining Grace |
| 16 | 10 Joker Burst | 41 | Extra Stars |
| 17 | 10 Crystal Wish | 42 | 40 Burning Hot |
| 18 | 20 Super Hot Epic Cash | 43 | 100 Super Hot |
| 19 | Burning Hot Epic Cash | 44 | 20 Hot Blast |
| 20 | Fury Princess | 45 | Volcano Wealth |
| 21 | Amazons' Battle 6 reels | 46 | Irish Charm |
| 22 | Retro Cabaret 6 reels | 47 | Almighty Realm |
| 23 | Flaming Hot 6 reels | 48 | 30 Spicy Fruits |
| 24 | 40 Burning Hot 6 reels | 49 | Emperor's Palace |
| 25 | Burning Hot 6 reels | 50 | Retro Cabaret |
| 26 | Eastern Carnival | 51 | Lucky Food |
| | | 52 | Mythical Treasure |
| | | 53 | Knights Heart |
| | | 54 | Tirol Fest |
| | | 55 | Rainbow Luck |
| | | 56 | Lucky Wood |
| | | 57 | Ice Valley |



Jackpots	Coin jackpot Jackpot Cards System Premium Link Jackpot System Lady's Card Jackpot System SAS-Progressive
Options & Features	Multi-denomination Autoplay Gamble Multi-language
Platform	
SAS Protocol	SAS 6.02
Cabinets	G 50 C ST G 50 C UP G 50 J1 ST G 50 J1 UP G 50 J2 ST G 50 J2 UP G 27-27 ST G 27-27 UP G 27-32 ST G 27-32 UP G 50 V ST G 55 C VIP G 55 J1 VIP G 32-32 VIP S 32-32 ST S 32-32 UP

FRUITS HD POWER

- | | |
|--|--|
| 1 Leprechaun Hot | 30 50 Spicy Fruits |
| 2 20 Super Hot | 31 40 Joker Reels |
| 3 Flaming Hot | 32 50 Hot Blast |
| 4 Burning Hot | 33 50 Mega Clover |
| 5 40 Burning Hot 6 Reels | 34 Extra Stars |
| 6-8 European Roulette
- Automatic Wheel
- Virtual Wheel
- Stand-alone Virtual Wheel | 35 Lucky & Wild
36 more Dice & Roll
37 27 Wins |
| 9 Star Blackjack | 38 Caramel Hot |
| 10 Flaming Hot Extreme | 39 10 Burning Heart |
| 11 5 Dazzling Hot | 40 40 Lucky King |
| 12 Shining Crown | 41 81 Wins |
| 13 30 Spicy Fruits | 42 Great 27 |
| 14 Burning Hot 6 reels | 43 Supreme Hot |
| 15 100 Super Hot | 44 Hot & Cash |
| 16 40 Super Hot | 45 40 Ultra Respin |
| 17 Flaming Hot 6 reels | 46 more Lucky & Wild |
| 18 Fruits Kingdom | 47 40 Extra Stars |
| 19 40 Burning Hot | 48 Extremely Hot |
| 20 100 Flaming Hot | 49 Lucky Hot |
| 21 100 Burning Hot | 50 40 Hot & Cash |
| 22 20 Hot Blast | 51 Super 20 |
| 23 40 Mega Clover | 52 20 Charming Joker |
| 24 20 Burning Hot | 53 Keno Universe |
| 25 Dice & Roll | 54 5 Juggle Fruits |
| 26 100 Lucky Hat | 55 Ultimate Hot |
| 27 20 Joker Reels | |
| 28 20 Dazzling Hot | |
| 29 40 Shining Crown | |

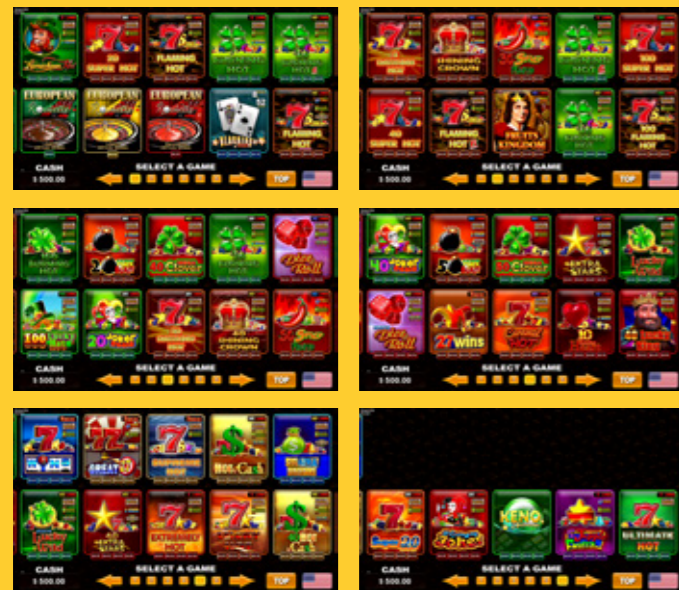

Jackpots	Coin jackpot Jackpot Cards System Premium Link Jackpot System Lady's Card Jackpot System SAS-Progressive
Options & Features	Multi-denomination Autoplay Gamble Multi-language
Platform	
SAS Protocol	SAS 6.02
Cabinets	G 50 C ST G 50 C UP G 50 J1 ST G 50 J1 UP G 50 J2 ST G 50 J2 UP G 27-27 ST G 27-27 UP G 27-32 ST G 27-32 UP G 50 V ST G 55 C VIP G 55 J1 VIP G 32-32 VIP S 32-32 ST S 32-32 UP

PURPLE HD POWER

- | | |
|--|--|
| 1 20 Super Hot | 30 Genie's Temple |
| 2 40 Super Hot | 31 20 Hot Blast |
| 3 Burning Hot | 32 50 Amazons' Battle |
| 4 Flaming Hot | 33 Dorothy's Fairyland |
| 5 Flaming Hot 6 reels | 34 Frog Story |
| 6-8 European Roulette
- Automatic Wheel
- Virtual Wheel
- Stand-alone Virtual Wheel | 35 Almighty Ramses II
36 Sweetie Dogs
37 Amazons' Battle 6 reels |
| 9 Star Blackjack | 38 Amazing China |
| 10 Irish Charm | 39 Glorious Hidalgo |
| 11 Amazons' Battle | 40 Almighty Ramses II
both ways |
| 12 5 Dazzling Hot | 41 40 Lucky King |
| 13 Shining Crown | 42 Zodiac Wheel |
| 14 Versailles Gold | 43 20 Dazzling Hot |
| 15 Rise of Ra | 44 Dice & Roll |
| 16 Eastern Legends | 45 The Story of Alexander |
| 17 Flower Land | 46 20 Burning Hot |
| 18 Lucky Food | 47 20 Joker Reels |
| 19 Leprechaun Hot | 48 40 Mega Clover |
| 20 El Amigo | 49 more Dice & Roll |
| 21 40 Burning Hot | 50 Ancient Dynasty |
| 22 100 Burning Hot | 51 Pin Up Queens |
| 23 100 Super Hot | 52 Rainbow Queen |
| 24 100 Flaming Hot | 53 Keno Universe |
| 25 30 Spicy Fruits | 54 Great Empire |
| 26 Golden Eternity | 55 Blue Heart |
| 27 Gangster's Cash | |
| 28 Mighty Sparta Epic Cash | |
| 29 Irish Treasure | |

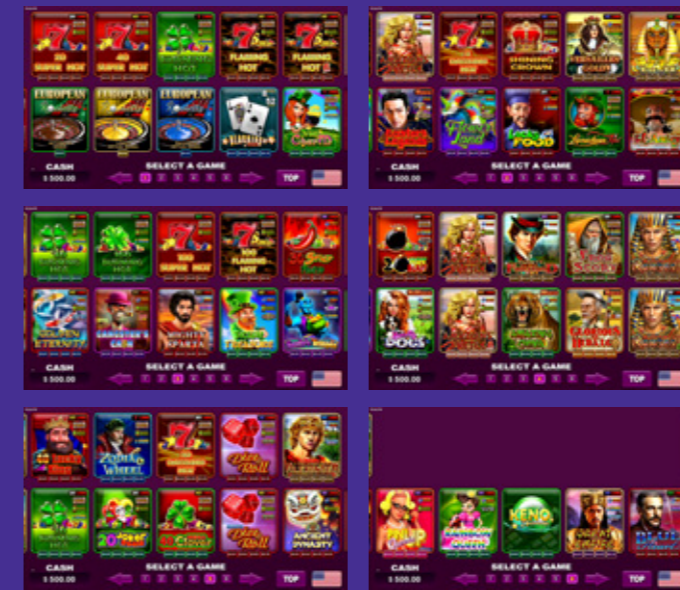



GOLD COLLECTION HD

Jackpots	Coin jackpot Jackpot Cards System Premium Link Jackpot System Lady's Card Jackpot System SAS-Progressive																								
Options & Features	Multi-denomination Autoplay Gamble Multi-language																								
Platform	EXCITER III																								
SAS Protocol	SAS 6.02																								
Cabinets	<table border="0"> <tr><td>Super Premier</td><td> G 50 V ST</td></tr> <tr><td>Super Premier 75</td><td> G 50 J1 ST</td></tr> <tr><td>P-42V St Curved</td><td> G 50 J1 UP</td></tr> <tr><td>P-42V Up Curved</td><td> G 50 J2 ST</td></tr> <tr><td>P-27/32H St</td><td> G 50 J2 UP</td></tr> <tr><td>P-27/27 St</td><td> G 50 C ST</td></tr> <tr><td>P-27/27 St Slim</td><td> G 50 C UP</td></tr> <tr><td>P-24/24 Up</td><td> G 27-32 ST</td></tr> <tr><td>G 55 C VIP</td><td> G 27-32 UP</td></tr> <tr><td>G 55 J1 VIP</td><td> G 27-27 ST</td></tr> <tr><td>G 32-32 VIP</td><td> G 27-27 UP</td></tr> <tr><td>S 32-32 ST</td><td> S 32-32 UP</td></tr> </table>	Super Premier	G 50 V ST	Super Premier 75	G 50 J1 ST	P-42V St Curved	G 50 J1 UP	P-42V Up Curved	G 50 J2 ST	P-27/32H St	G 50 J2 UP	P-27/27 St	G 50 C ST	P-27/27 St Slim	G 50 C UP	P-24/24 Up	G 27-32 ST	G 55 C VIP	G 27-32 UP	G 55 J1 VIP	G 27-27 ST	G 32-32 VIP	G 27-27 UP	S 32-32 ST	S 32-32 UP
Super Premier	G 50 V ST																								
Super Premier 75	G 50 J1 ST																								
P-42V St Curved	G 50 J1 UP																								
P-42V Up Curved	G 50 J2 ST																								
P-27/32H St	G 50 J2 UP																								
P-27/27 St	G 50 C ST																								
P-27/27 St Slim	G 50 C UP																								
P-24/24 Up	G 27-32 ST																								
G 55 C VIP	G 27-32 UP																								
G 55 J1 VIP	G 27-27 ST																								
G 32-32 VIP	G 27-27 UP																								
S 32-32 ST	S 32-32 UP																								



GOLD COLLECTION HD

- | | |
|----------------------------|---------------------------------|
| 1 20 Super Hot | 30 Amazing China |
| 2 40 Super Hot | 31 Almighty Ramses II |
| 3 Burning Hot | 32 Almighty Ramses II both ways |
| 4 5 Dazzling Hot | 33 El Amigo |
| 5 Flaming Hot | 34 Sweetie Dogs |
| 6 Amazons' Battle | 35 Irish Treasure |
| 7 Lucky Food | 36 Genie's Temple |
| 8 Irish Charm | 37 30 Spicy Fruits |
| 9 Flaming Hot 6 reels | 38 Dorothy's Fairyland |
| 10 Amazons' Battle 6 reels | 39 more Dice & Roll |
| 11 Flower Land | 40 The Story of Alexander |
| 12 Eastern Legends | 41 Great Empire |
| 13 Shining Crown | 42 50 Amazons' Battle |
| 14 Versailles Gold | 43 20 Dazzling Hot |
| 15 Dice & Roll | 44 Blue Heart |
| 16 20 Joker Reels | 45 Rainbow Queen |
| 17 Rise of Ra | 46 Pin Up Queens |
| 18 40 Burning Hot | 47 Zodiac Wheel |
| 19 20 Burning Hot | 48 40 Mega Clover |
| 20 Glorious Hidalgo | |
| 21 Leprechaun Hot | |
| 22 Golden Eternity | |
| 23 Gangster's Cash | |
| 24 Mighty Sparta | |
| 25 100 Super Hot | |
| 26 100 Burning Hot | |
| 27 40 Lucky King | |
| 28 100 Flaming Hot | |
| 29 20 Hot Blast | |

The background is a solid red color. It features several sets of white, parallel lines that curve and flow across the page. One set of lines is in the top-left corner, another set is in the bottom-right corner, and a third set is in the bottom-center area, partially overlapping the text. The lines vary in thickness and spacing, creating a sense of movement and depth.

ACCESSORIES

General Jackpot Panels

LED Panel General Big Dual-sided

- Dual-sided, LED jackpot panel
- Attractive animations, traversing all sides of the panel
- Thematic RGB illumination on top and bottom frame
- Enhanced quality stereo sound system
- Easy installation servicing
- Available with all cabinets of series General
- Display dimensions:
WxHxD: 2135 | 844 | 405 mm

AVAILABLE JACKPOTS

Each jackpot is compatible with any panel.



LED Panel General Small Dual-sided

- Dual-sided, LED jackpot panel
- Attractive animations, traversing all sides of the panel
- Thematic RGB illumination on top and bottom frame
- Enhanced quality stereo sound system
- Easy installation servicing
- Available with all cabinets of series General
- Display dimensions:
WxHxD: 1366 | 844 | 405 mm

AVAILABLE JACKPOTS

Each jackpot is compatible with any panel.



General Jackpot Panels

LED Panel Rounded Large
Double | Single

- Enhanced quality stereo sound system
- Easy installation servicing
- Available with all cabinets of series General
- Display dimensions:
Double: WxHxD 2009 | 646 | 496mm
Single: WxHxD 2009 | 646 | 208mm

AVAILABLE JACKPOTS
Each jackpot is compatible with any panel.



LED Panel Rounded Small
Double | Single

- Enhanced quality stereo sound system
- Easy installation servicing
- Available with all cabinets of series General
- Display dimensions:
Double: WxHxD 2009 | 325 | 496mm
Single: WxHxD 2009 | 325 | 207mm

AVAILABLE JACKPOTS
Each jackpot is compatible with any panel.



General Jackpot Panels

LED Panel Flat Large
Double | Single

- Enhanced quality stereo sound system
- Easy installation servicing
- Available with all cabinets of series General
- Display dimensions:
Double: WxHxD 2118 | 774 | 494 mm
Single: WxHxD 2009 | 646 | 100 mm

AVAILABLE JACKPOTS
Each jackpot is compatible with any panel.



LED Panel Flat Small
Double | Single

- Enhanced quality stereo sound system
- Easy installation servicing
- Available with all cabinets of series General
- Display dimensions:
Double: WxHxD 2118 | 390 | 494 mm
Single: WxHxD 2009 | 390 | 100 mm

AVAILABLE JACKPOTS
Each jackpot is compatible with any panel.



General Jackpot Panels

LED Panel Oval Large

- 360° LED jackpot panel
- Elevated audio experience
- Easy-to-install and service
- Available with all cabinets of series General
- Display dimensions:
WxHxD 1847 | 642 | 407 mm

AVAILABLE JACKPOTS

Each jackpot is compatible with any panel.



LED Panel Oval Small

- 360° LED jackpot panel
- Elevated audio experience
- Easy-to-install and service
- Available with all cabinets of series General
- Display dimensions:
WxHxD 2007 | 321 | 407 mm

AVAILABLE JACKPOTS

Each jackpot is compatible with any panel.



LED Panel Circle new

Large & Small

- 360° LED jackpot panel
- Display dimensions:
Large: WxHxD 1847 | 642 | 407 mm
Small: WxHxD 1847 | 642 | 407 mm
- Available for cabinets:
G 27-27 UP | G 27-27 ST
G 50 C UP | G 50 C ST
G 50 J1 UP | G 50 J1 ST
G 50 J2 UP | G 50 J2 ST
G 50 V ST

AVAILABLE JACKPOTS

Each jackpot is compatible with any panel.



Light Decoration G-Series new

Introducing the Light Decoration G-Series, a new accessory with easy installation and energy-efficient LED technology. It is a durable and cost-effective solution to create the perfect ambiance and elevate the gaming experience for your players.

- The lighting settings are adjustable, allowing for customizable effects.
- The additional lighting improves visibility for players
- The accessory maintains the sleek design and branding of EGT cabinets.

AVAILABLE CABINETS

G 50 C ST

G 50 J1 ST

G 50 J2 ST

G 50 V ST

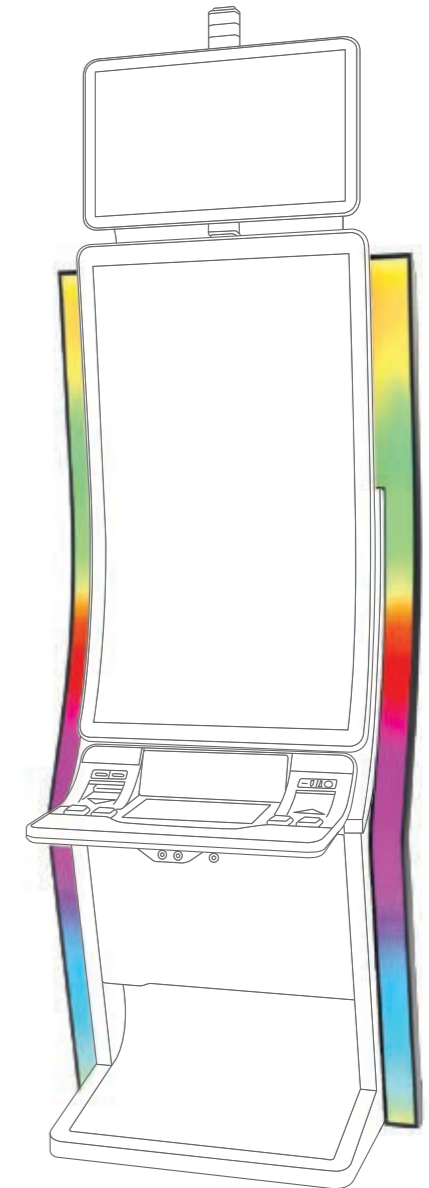

Shelf Space Accessories

Shelf Space Accessory VIP Cabinets

- Attractive design that follows the main concept of the General panels and cabinets
- Convenient table, ensuring maximum comfort for the players
- WxHxD 477x1845x742 mm

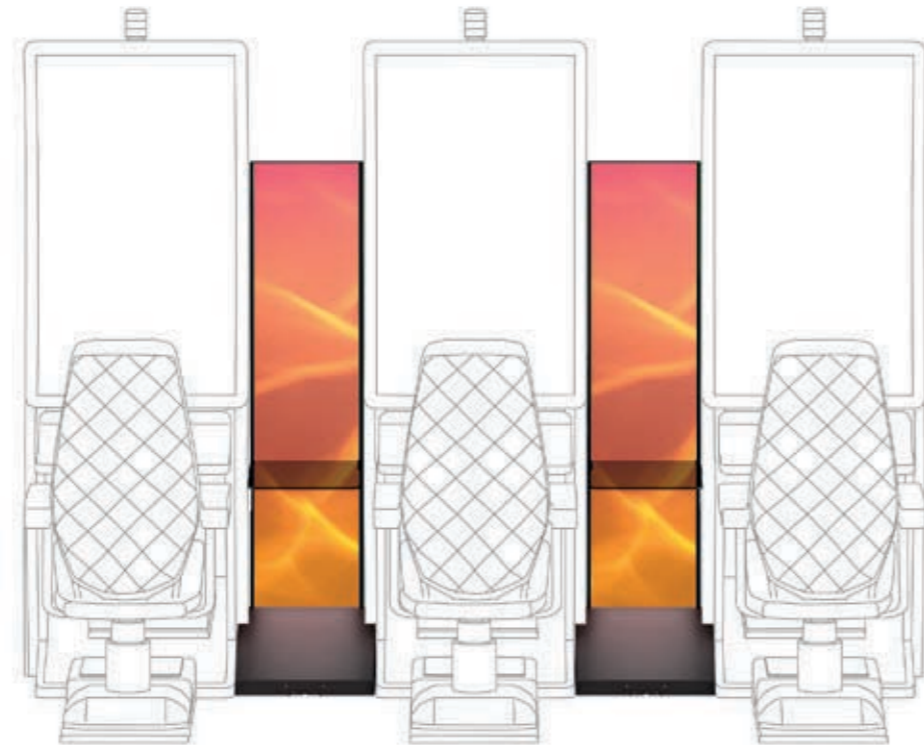

Shelf Space Accessory Slant top Cabinets

- WxHxD 210x1670x743 mm

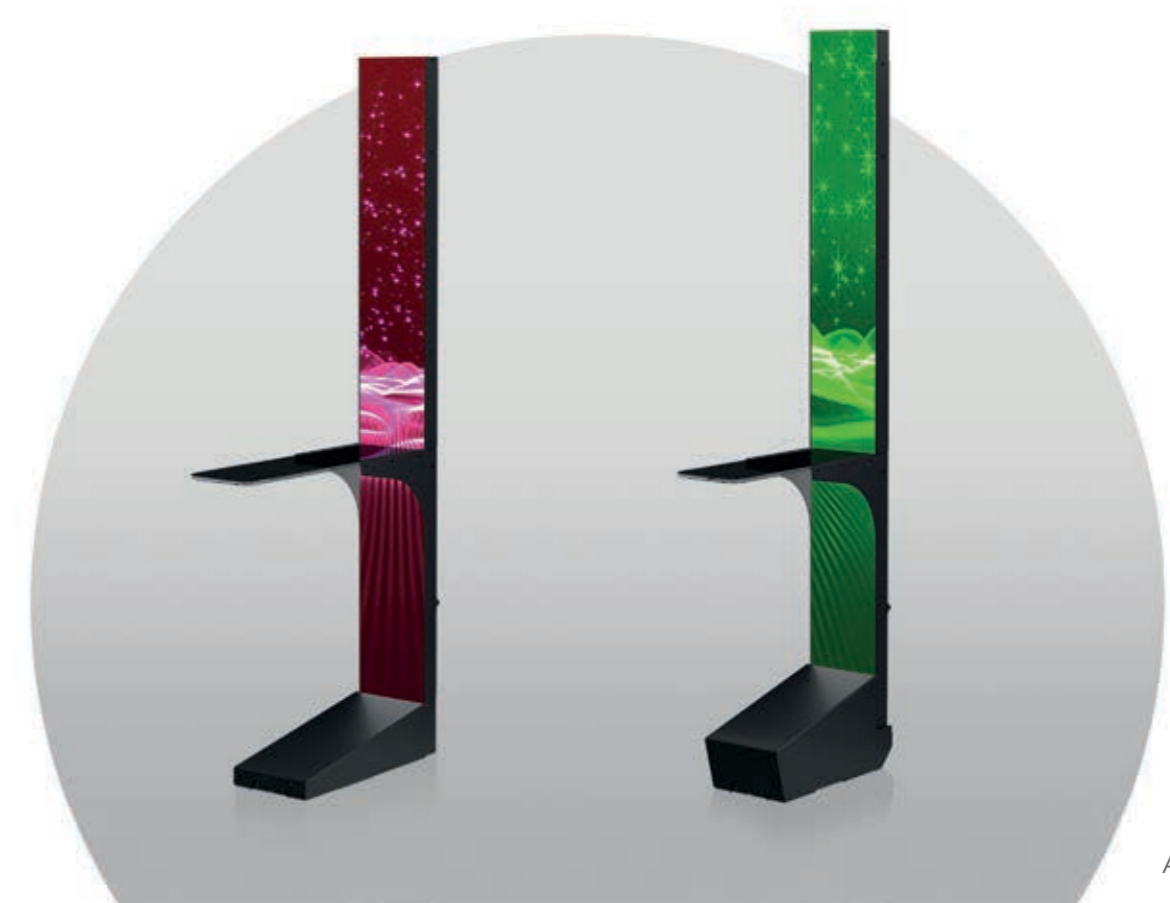
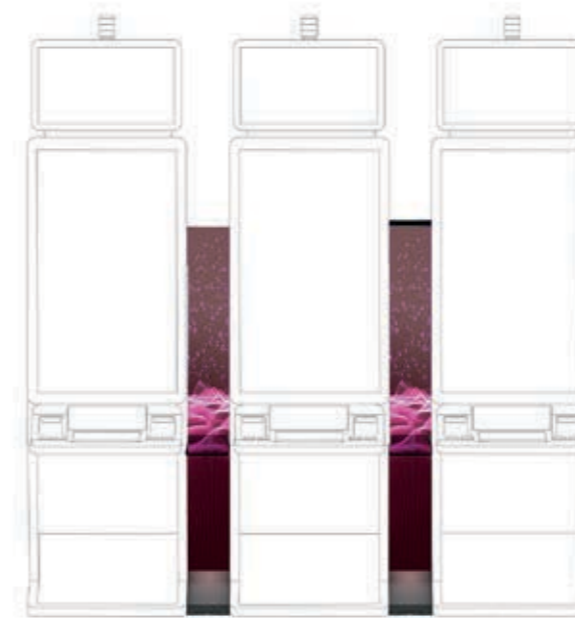

Shelf Space Accessory Upright Cabinets

- WxHxD 210x1775x621 mm



Bank End Advertising

Slant top / Upright & VIP cabinets

- Design that follows the General panels & cabinets main concept
- Created to grab the attention with its attractive animations
- Bank End Advertising Slant top
WxH 388x1669 mm
- Bank End Advertising Upright/VIP
WxH 388x1777 mm



Slant top & VIP cabinets 45°

- Design that follows the General panels & cabinets main concept
- Created to grab the attention with its attractive animations
- Bank End Advertising Slant top
WxH 210x1670 mm
- Bank End Advertising VIP cabinet
WxH 477x1845 mm

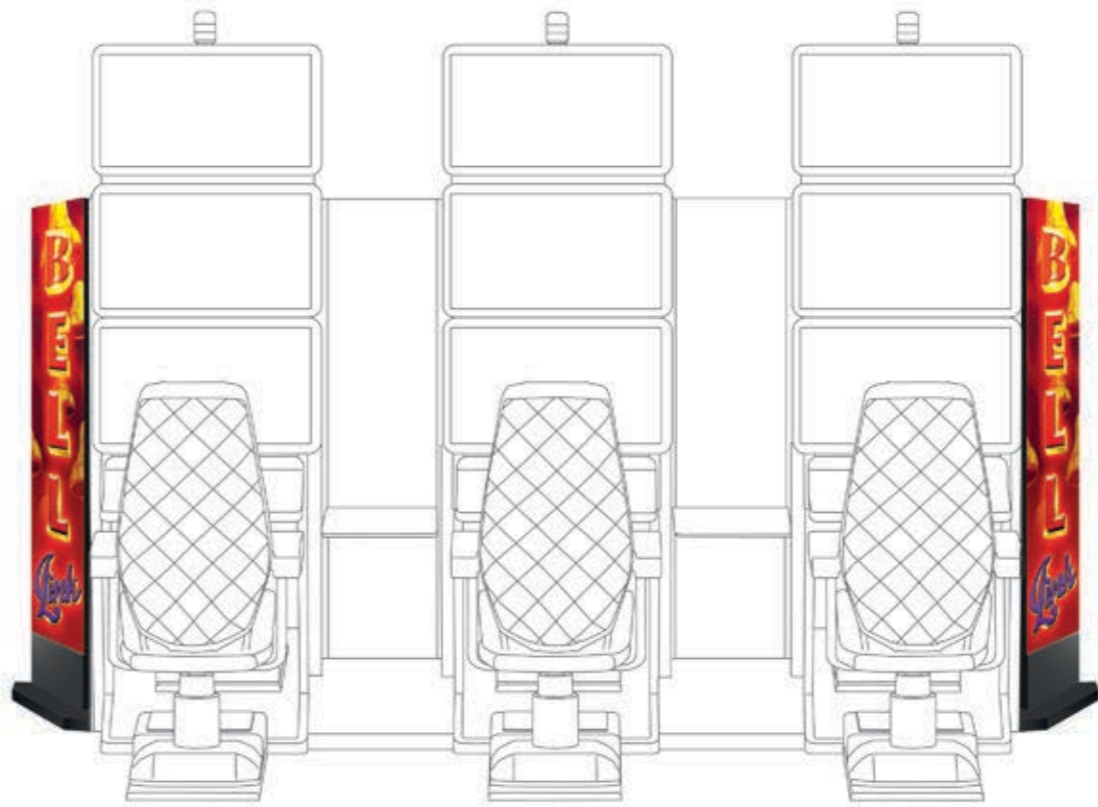

General Toppers

- 27" or 32" high-resolution monitor
- Attractive lighting and appearance that follows the General cabinets design line
- Available for playing attractive, grabbing the attention movies
- Option for displaying jackpots
- 32": WxH 765,5x935,1 mm
- 27": WxH 663x821,2 mm



**ELECTRONIC TABLE
GAMES ACCESSORIES**

EGT LED Video Wall new

Small | Medium | Large

- Enhanced video quality
- Easy installation/servicing
- Display dimensions:
Small: WxHxD 3040|2710|120 mm
Medium: WxHxD 3648|3052|120 mm
Large: WxHxD 4256|3394|120 mm
- Available roulette views:
Panorama horizontal view
Classic horizontal view
Power horizontal view

AVAILABLE ROULETTE JACKPOT PANELS

Jackpot Cards	Coin Jackpot
Lady's Cards	Premium Link
Diamond Number	



Shelf Space Accessories

G-series Terminals Connections
0° | 12° | 45° | 60° | 90°

- 0° - Made for an arc or low angle setups
- 12° - Made for an arc or low angle setups
- 45°, 60°, 90° - Made for corner setups
- Front printed abstract design lightbox (Optional)
- Tempered glass in black color (Transparent crystal clear option is available)



The background is a solid red color with several sets of white, parallel, rounded lines that create a sense of depth and movement. One set of lines is in the top-left corner, another set is in the bottom-right corner, and a third set is in the bottom-center, all appearing to recede into the distance.

GLOBAL SOLUTION
VLT SYSTEM

VLT

GLOBAL SOLUTION

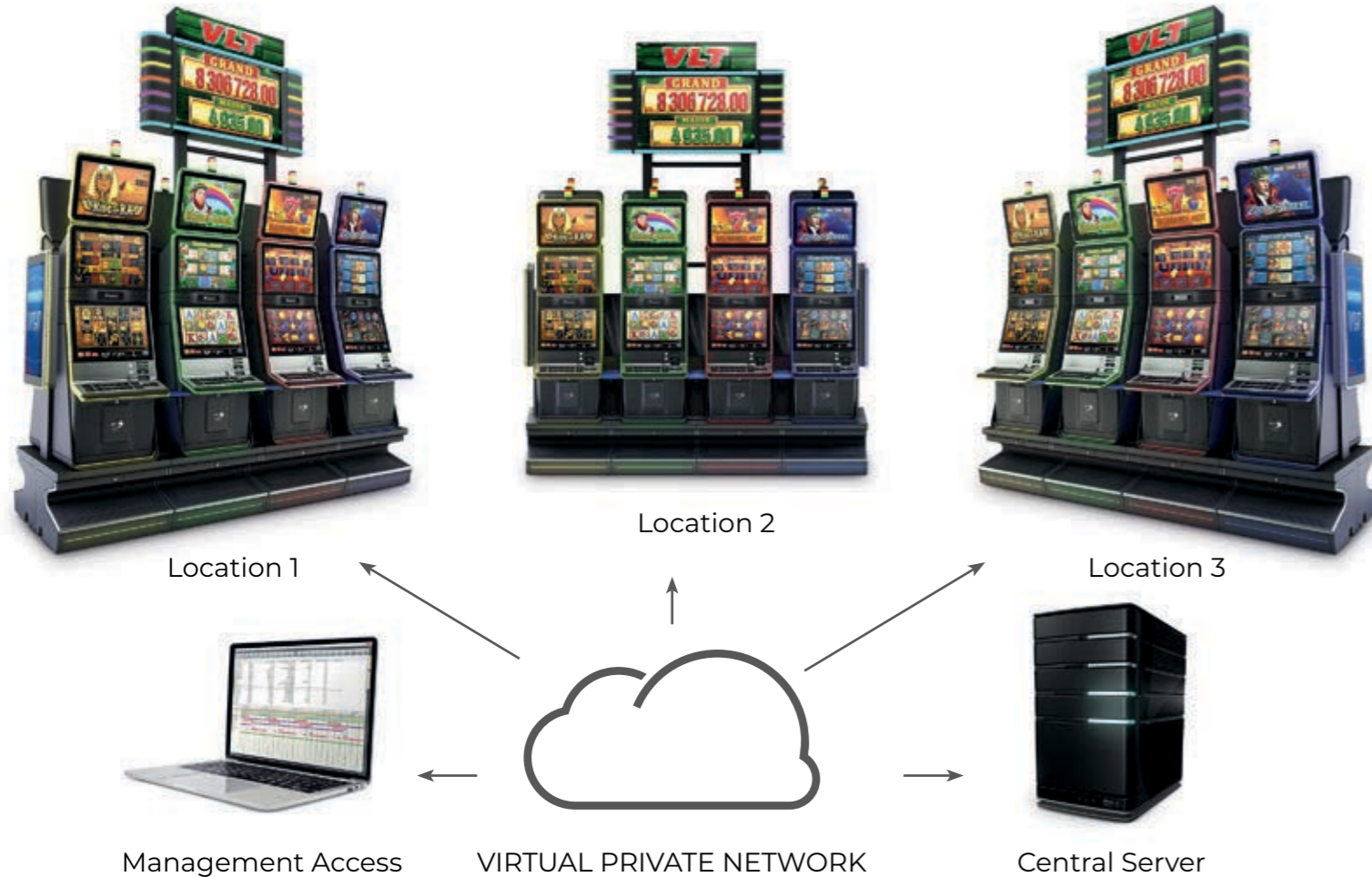

EGT's **Global Solution VLT** is a server-based system that comprises two main components – **Central Server** and **Locations**, with an unlimited number of locations that can be connected to the Central Server.

Overall, the **Global Solution VLT** system is made to be flexible, easy to use, has a built-in ticketing system and can be modified to satisfy the clients' needs, making it very adaptable to business and regulatory requirements.

VLT Jackpot

The VLT Mystery jackpot can be either a Global or Local jackpot, each with three levels. All machines in the country are eligible, and each location can feature up to six jackpot levels. The Local Jackpot is specific to certain locations and partners, which are individual companies owning one or more locations. Jackpot payouts can be made via credit or ticket.



Central Server

The server, located in the operating country, features VPN-only access and backup security, connecting solely to our cabinets. Each partner market has a dedicated server and login for accessing location stats and customizing settings. Clustered server organization ensures optimal performance and reliability.

- Games management and settings
- RNG
- Administrative support:
 - Accounting and reporting
 - Terminals monitoring
 - Network monitoring
 - Server monitoring
- Distributed load balance Processing
- Cluster server organization for optimal performance and maximum reliability

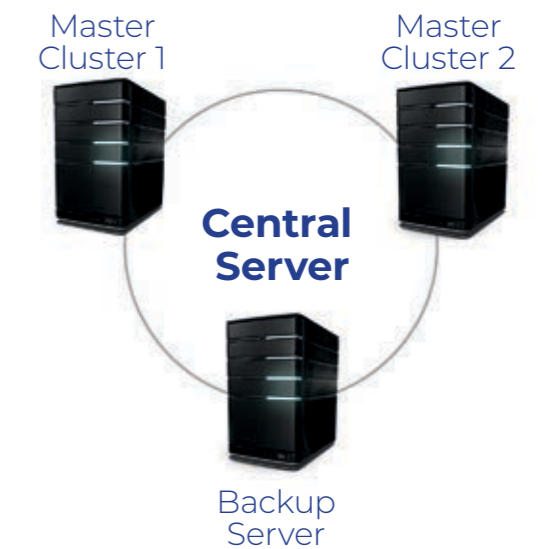

Communication Network

- Provides data traffic between the central server and the locations
- Advantages:
 - Site-To-Site VPN
 - SSL certificate authorization
 - Easy system scaling
- Communication based on TCP/IP with TLS and RSA Encryption over the VPN

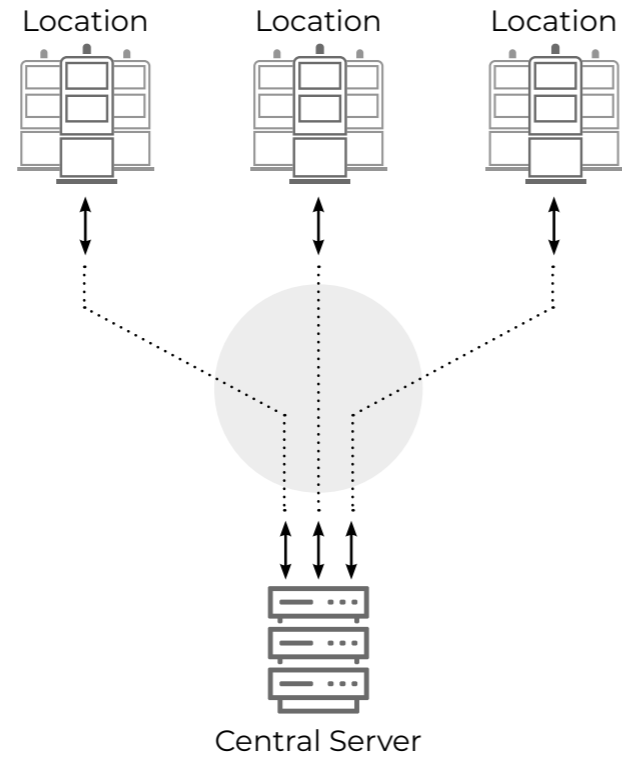

Locations



MANAGEMENT ACCESS

Data Reports & Analysis

The system exports and reports data in real-time, maintaining a detailed history of played games for each terminal. It logs all terminal events, including game activity, machine access, errors, and setting changes, ensuring comprehensive monitoring and troubleshooting.

- VLT terminals:
 - 2 x widescreen displays
 - Topper (optional)
 - Bill acceptor
 - Coin acceptor
 - Ticket printer
 - Powered by Exciter II and Exciter III Gaming Platforms
 - Include well-known and proven games with high definition graphics
- Cash Desk:
 - Validation of issued tickets
 - History of last 10 validated tickets
 - Simple operation
 - Daily ticketing reporting
- Jackpot Media Player

VLT

GLOBAL SOLUTION



MULTIGAMES

Jackpots	VLT Jackpot
Options & Features	Multi-denomination Autoplay Gamble Multi-language
Platform	
SAS Protocol	SAS 6.02
Cabinets	G 27-27 UP G 27-27 ST P-27/32H St P-27/27 St P-27/27 St Slim P-24/24 Up

GREEN VLT

- | | |
|---------------------------|------------------------|
| 1 20 Super Hot | 19 20 Joker Reels |
| 2 40 Super Hot | 20 20 Hot Blast |
| 3 100 Super Hot | 21 Dorothy's Fairyland |
| 4 5 Dazzling Hot | 22 Brave Cat |
| 5 Burning Hot | 23 Fortune Spells |
| 6 40 Burning Hot | 24 Egypt Sky |
| 7 Flaming Hot | 25 Extremely Hot |
| 8 Amazons' Battle | 26 40 Lucky King |
| 9 Ancient Dynasty | 27 Dice & Roll |
| 10 Pin Up Queens | 28 more Dice&Roll |
| 11 The Story of Alexander | 29 Lucky Hot |
| 12 Almighty Ramses II | 30 Ultimate Hot |
| 13 Shining Crown | 31 Olympus Glory |
| 14 40 Mega Clover | 32 Majestic Forest |
| 15 30 Spicy Fruits | 33 Age of Troy |
| 16 Extra Stars | 34 Fruits Kingdom |
| 17 Rise of Ra | 35 Secrets of Alchemy |
| 18 Versailles Gold | 36 Oil Company II |



Jackpots	VLT Jackpot
Options & Features	Multi-denomination Autoplay Gamble Multi-language
Platform	
SAS Protocol	SAS 6.02
Cabinets	G 27-27 UP G 27-27 ST P-27/32H St P-27/27 St P-27/27 St Slim P-24/24 Up

RED VLT

- | | |
|---------------------------|-----------------------|
| 1 20 Super Hot | 30 Zodiac Wheel |
| 2 40 Super Hot | 31 Ancient Dynasty |
| 3 Burning Hot | 32 Gold Dust |
| 4 5 Dazzling Hot | 33 Imperial Wars |
| 5 Flaming Hot | 34 Olympus Glory |
| 6 Amazons' Battle | 35 Game of Luck |
| 7 50 Amazons' Battle | 36 Penguin Style |
| 8 Pin Up Queens | 37 Brave Cat |
| 9 The Story of Alexander | 38 Extremely Hot |
| 10 20 Joker Reels | 39 27 Wins |
| 11 30 Spicy Fruits | 40 Great 27 |
| 12 40 Mega Clover | 41 Secrets of Alchemy |
| 13 Shining Crown | 42 Supreme Hot |
| 14 Versailles Gold | 43 The White Wolf |
| 15 Dice & Roll | 44 Book of Magic |
| 16 Extra Stars | 45 Dragon Reborn |
| 17 Rise of Ra | 46 Witches' Charm |
| 18 Fortune Spells | 47 Egypt Sky |
| 19 40 Burning Hot | 48 81 Wins |
| 20 20 Hot Blast | |
| 21 Frog Story | |
| 22 Almighty Ramses II | |
| 23 Captain Nemo's Journey | |
| 24 Dorothy's Fairyland | |
| 25 20 Charming Joker | |
| 26 20 Dazzling Hot | |
| 27 Lucky Hot | |
| 28 Ultimate Hot | |
| 29 5 Juggle Fruits | |

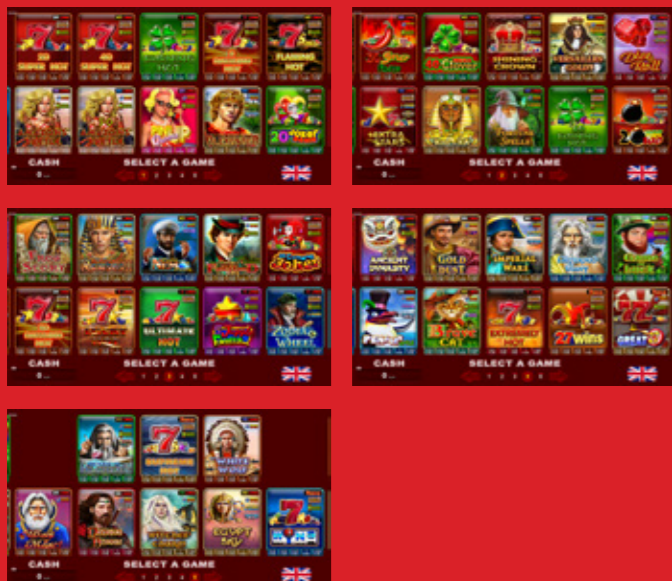

Jackpots	VLT Jackpot
Options & Features	Multi-denomination Autoplay Gamble Multi-language
Platform	
SAS Protocol	SAS 6.02
Cabinets	G 27-27 UP G 27-27 ST P-27/32H St P-27/27 St P-27/27 St Slim P-24/24 Up

PURPLE VLT

- | | |
|---------------------------|--------------------------|
| 1 20 Super Hot | 25 20 Charming Joker |
| 2 40 Super Hot | 26 20 Dazzling Hot |
| 3 Burning Hot | 27 Lucky Hot |
| 4 5 Dazzling Hot | 28 Ultimate Hot |
| 5 Flaming hot | 29 Dice & Roll |
| 6 Amazons' Battle | 30 more Dice & Roll |
| 7 Burning Hot 6 reels | 31 50 Amazons' Battle |
| 8 Rainbow Luck | 32 Blue Oceans |
| 9 Flaming Hot Extreme | 33 40 Lucky King |
| 10 Volcano Wealth | 34 Genius of Leonardo |
| 11 20 Burning Hot | 35 The Secrets of London |
| 12 Vampire Night | 36 Retro Cabaret |
| 13 Shining Crown | 37 Brave Cat |
| 14 40 Mega Clover | 38 Circus Brilliant |
| 15 40 Burning Hot | 39 Rainbow Queen |
| 16 Extra Stars | 40 Empress Charm |
| 17 Rise Of Ra | 41 Secrets of Alchemy |
| 18 Versailles Gold | 42 Fortune Spells |
| 19 40 Burning hot 6 reels | 43 Captain's Nemo Jorney |
| 20 Cats Royal | 44 Fruits Kingdom |
| 21 Lucky Wood | 45 Ancient Dynasty |
| 22 Almighty Ramsess II | 46 Olympus Glory |
| 23 30 Spicy Fruits | 47 Egypt Sky |
| 24 100 Super hot | 48 Dorothy's Fairyland |

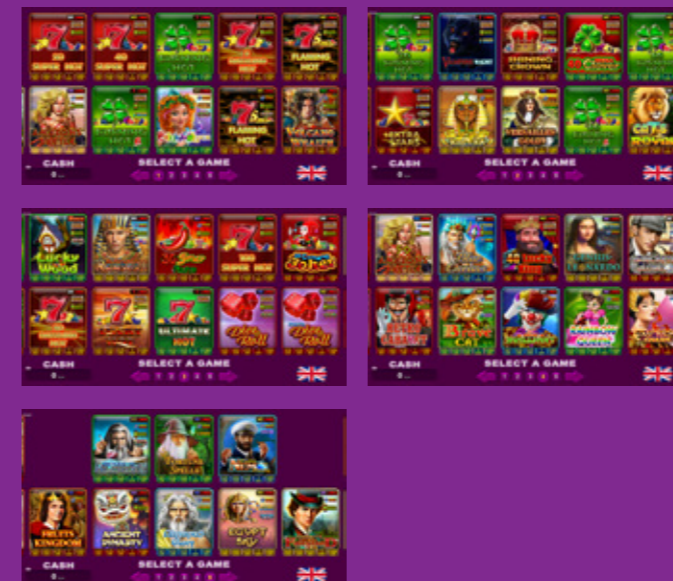

Jackpots	VLT Jackpot
Options & Features	Multi-denomination Autoplay Gamble Multi-language
Platform	
SAS Protocol	SAS 6.02
Cabinets	P-27/32H St P-27/27 St P-27/27 St Slim P-24/24 Up

ORANGE COLLECTION VLT

The Orange Collection VLT enables the operator to choose the participating games in the mix and to arrange their positions on the screen – a feature that customizes the product according to various tastes and requirements and is highly appreciated by the customers.



Platform	
Cabinets	G 27-27 ST G 27-27 UP
G2S classes	Communications Class Cabinet Class GamePlay Class Download GAT NoteAcceptor Class IdReader Class PUI Player Class InformedPlayer Class MediaDisplay Class MMJ Class PLR Class Wat Class Handpay Class Chooser class

G2S
ready





Jackpots	G2S Mystery jackpot
Options & Features	Autoplay Gamble Multi-language
Platform	EXCITER III
SAS Protocol	G2S
Cabinets	G 27-27 UP G 27-27 ST

You could select by:

- Cash Prize
- Free Spins
- Fruit Games
- Tetra Spins
- Top Games

All games:

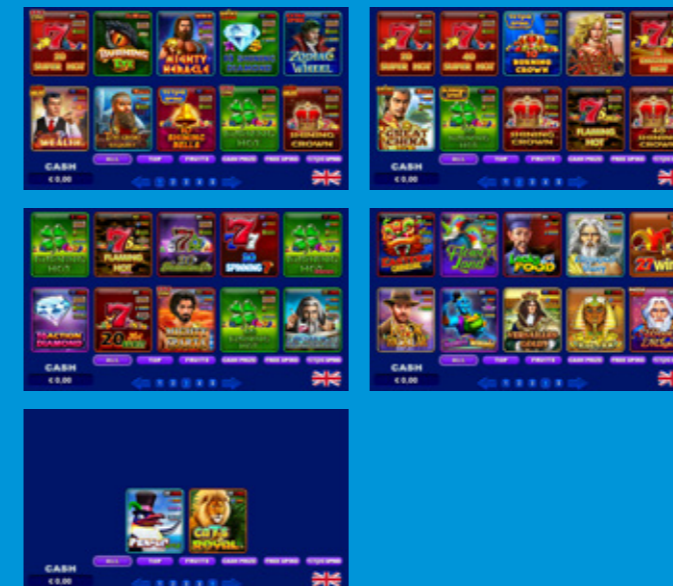

VLT

Greece G2S

- | | |
|--------------------------------|-------------------------------------|
| 1 20 Super Hot | 22 Flower Land |
| 2 40 Super Hot | 23 20 Diamonds |
| 3 40 Burning Hot | 24 30 Spinning 7's |
| 4 40 Shining Crown | 25 Lucky Food |
| 5 Flaming Hot | 26 Cats Royal |
| 6 Shining Crown
Cash Heat | 27 Rise of Ra |
| 7 The Great Exploit | 28 Secrets of Alchemy |
| 8 Book of Magic
Dazzle Cash | 29 Versailles Gold |
| 9 Book of Realm | 30 Olympus Glory |
| 10 Flaming Hot Extreme | 31 Penguin Style |
| 11 20 Super Hot
Epic Cash | 32 10 Burning Hot
Burning Spins |
| 12 Mighty Sparta
Epic Cash | 33 10 Burning Crown
Tetra Spins |
| 13 Burning Hot | 34 Burning Hot Extreme |
| 14 Shining Crown | 35 27 Wins |
| 15 Amazons' Battle | 36 Great China
Shiny Cash |
| 16 20 Hot Burst | 37 10 Shining Bells
Tetra Spins |
| 17 Burning Hot
Epic Cash | 38 10 Shining
Diamond Shiny Cash |
| 18 5 Dazzling Hot | 39 Exquisite Wealth
Cash Heat |
| 19 10 Action Diamonds | 40 Zodiac Wheel
Extra Spins |
| 20 Eastern Carnival | 41 Burning Eye |
| 21 Genie's Temple | |



VLT ITALY

Options & Features	Autoplay Gamble Multi-language
Platform	Microsoft Windows based PC
Cabinets	P-27/32H St P-27/27 St Slim P-24/24 Up



VLT ITALY

- 1 Burning Hot Coins
- 2 Zodiac Wheel Coins
- 3 10 Joker Reels Coins
- 4 20 Super Hot Coins
- 5 Zodiac Wheel
- 6 Book of Realm
Burning Spins
- 7 81 Wins
- 8 50 Burning Hot
- 9 Almighty Ramses II
- 10 Burning Hot
- 11 27 Wins
- 12 10 Jocker Reels
- 13 Olympus Glory
- 14 Witches' Charm
- 15 Rise of Ra
- 16 Dreams of Gods
- 17 40 Super Hot
Burning Spins

Jackpots	Jackpot GS
Options & Features	Multi-denomination Autoplay Gamble Multi-language
Platform	
SAS Protocol	SAS 6.02
Cabinets	P-27/32H St P-27/27 St P-27/27 St Slim P-24/24 Up

Romanian Market

RED COLLECTION GS

- | | |
|---------------------------|-----------------------|
| 1 20 Super Hot | 26 20 Dazzling Hot |
| 2 40 Super Hot | 27 Lucky Hot |
| 3 Burning Hot | 28 Ultimate Hot |
| 4 5 Dazzling Hot | 29 5 Juggle Fruits |
| 5 Flaming Hot | 30 Zodiac Wheel |
| 6 Amazons' Battle | 31 Ancient Dynasty |
| 7 50 Amazons' Battle | 32 Gold Dust |
| 8 Pin Up Queens | 33 Imperial Wars |
| 9 The Story of Alexander | 34 Olympus Glory |
| 10 20 Joker Reels | 35 Game of Luck |
| 11 30 Spicy Fruits | 36 Penguin Style |
| 12 40 Mega Clover | 37 Brave Cat |
| 13 Shining Crown | 38 Extremely Hot |
| 14 Versailles Gold | 39 27 Wins |
| 15 Dice & Roll | 40 Great 27 |
| 16 Extra Stars | 41 Secrets of Alchemy |
| 17 Rise of Ra | 42 Supreme Hot |
| 18 Fortune Spells | 43 The White Wolf |
| 19 40 Burning Hot | 44 Book of Magic |
| 20 20 Hot Blast | 45 Dragon Reborn |
| 21 Frog Story | 46 Witches' Charm |
| 22 Almighty Ramses II | 47 Egypt Sky |
| 23 Captain Nemo's Journey | 48 81 Wins |
| 24 Dorothy's Fairyland | |
| 25 20 Charming Joker | |

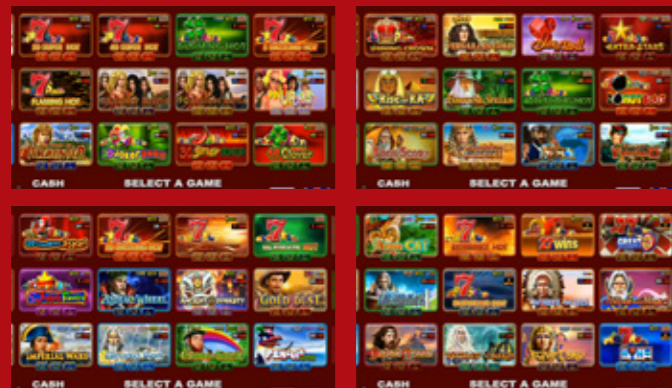

Jackpots	Jackpot GS
Options & Features	Multi-denomination Autoplay Gamble Multi-language
Platform	
SAS Protocol	SAS 6.02
Cabinets	P-27/32H St P-27/27 St P-27/27 St Slim P-24/24 Up

Romanian Market

GREEN COLLECTION GS

- | | |
|---------------------------|-----------------------|
| 1 20 Super Hot | 26 40 Lucky King |
| 2 40 Super Hot | 27 Dice & Roll |
| 3 100 Super Hot | 28 more Dice & Roll |
| 4 5 Dazzling Hot | 29 Lucky Hot |
| 5 Burning Hot | 30 Ultimate Hot |
| 6 40 Burning Hot | 31 Olympus Glory |
| 7 Flaming Hot | 32 Majestic Forest |
| 8 Amazons' Battle | 33 Age of Troy |
| 9 Ancient Dynasty | 34 Fruits Kingdom |
| 10 Pin Up Queens | 35 Secrets of Alchemy |
| 11 The Story of Alexander | 36 Oil Company II |
| 12 Almighty Ramses II | |
| 13 Shining Crown | |
| 14 40 Mega Clover | |
| 15 30 Spicy Fruits | |
| 16 Extra Stars | |
| 17 Rise of Ra | |
| 18 Versailles Gold | |
| 19 20 Joker Reels | |
| 20 20 Hot Blast | |
| 21 Dorothy's Fairyland | |
| 22 Brave Cat | |
| 23 Fortune Spells | |
| 24 Egypt Sky | |
| 25 Extremely Hot | |





AWP
CABINETS

G 32-32 VIP AWP



- Two high-resolution 32" widescreen monitors
- Touch screen equipped on the main display
- Overhead multimedia topper with a 32" monitor (optional)
- Frameless HD display with exceptional visual clarity
- Exquisite design and ergonomic features, ensuring maximum comfort
- Wide and convenient keyboard with dynamic touch display and electromechanical buttons
- Specially designed key systems for more ease of use by an operator
- High-quality stereo sound system
- Ambient, attractive LED illumination alongside the cabinet
- Built-in USB port for fast charging
- Powered by **EXCITER III**® and **EXCITER IV**® platform

Comfortable multimedia chair that includes:

- High-quality stereo sound speakers
- Sound volume control
- The functions: Start, Auto Play, Select Game, Gamble, Take Win, Select Bet and Lines

Peripheral Devices:

- Printer (Ticket-In and Ticket-Out)
- Bill recycler
- Coin acceptor
- Hopper

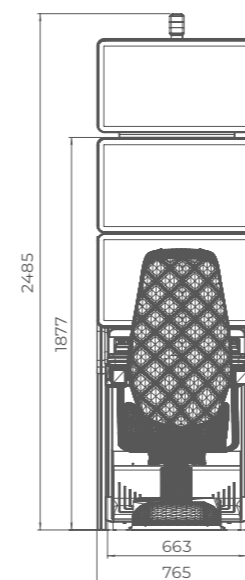
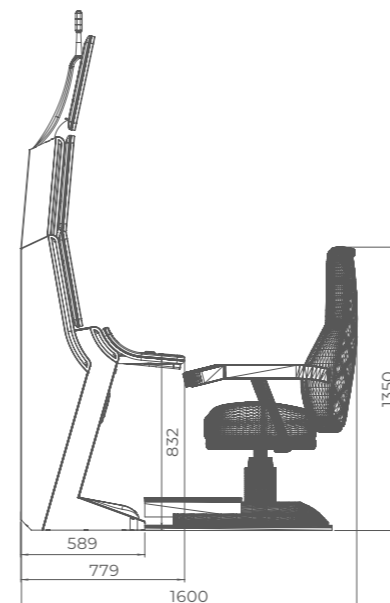

Dynamic touch keyboard

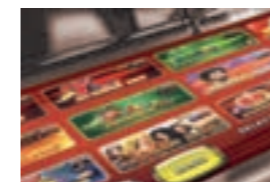

G 27-27 ST AWP



- Two high-resolution 27" widescreen monitors
- Touch screen equipped on the main display
- Overhead multimedia topper with a 27" monitor (optional)
- Frameless HD display with exceptional visual clarity
- Exquisite design and ergonomic features, ensuring maximum comfort
- Wide and convenient keyboard with dynamic touch display and electromechanical buttons
- Specially designed key systems for more ease of use by an operator
- High-quality stereo sound system
- Ambient, attractive LED illumination alongside the cabinet
- Built-in USB port for fast charging
- Powered by **EXCITER III** and **EXCITER IV** platform

Peripheral Devices:

- Printer (Ticket-In and Ticket-Out)
- Bill validator
- Coin acceptor

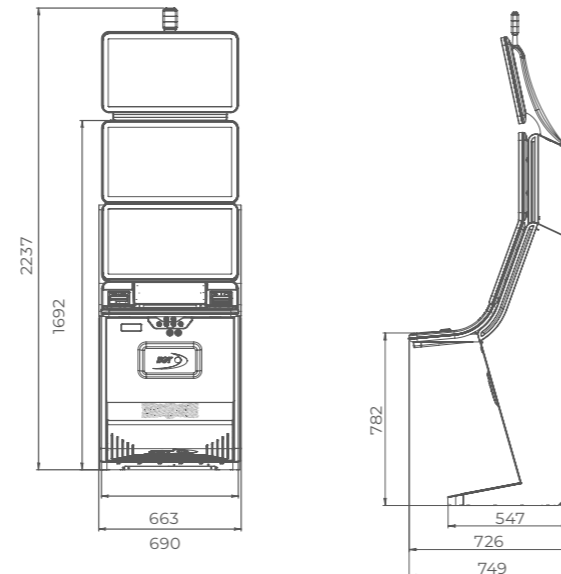

Phoenix

PH 27-27 ST AWP

- 27" monitors
- Exquisite design and ergonomic features ensure maximum comfort
- Video or electromechanical keyboard
- Ambient, attractive LED illumination alongside the cabinet
- Latest EGT software available
- Powered by **EXCITER III** and **EXCITER IV** platform

Peripheral Devices:

- Bill acceptor
- Ticket printer
- Coin Acceptor
- Hopper

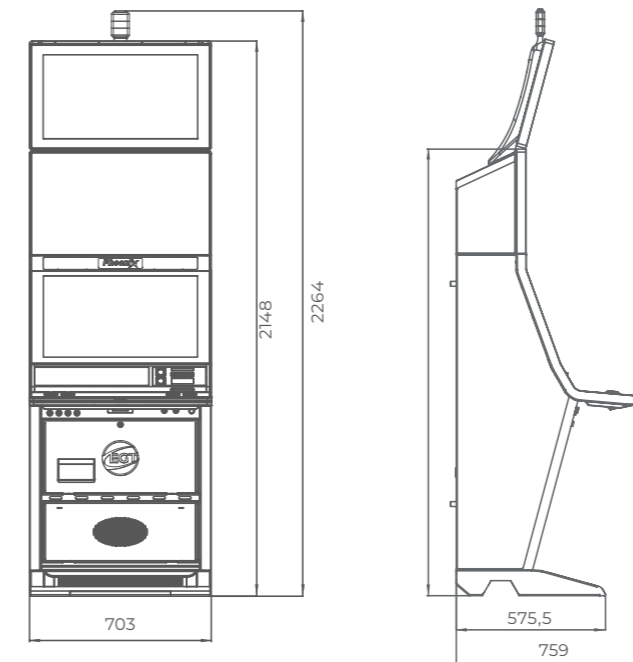

P-24/24 UP AWP



- Two high-resolution 24" widescreen monitors, the main one with an integrated touch screen for greater interactivity
- Overhead multimedia topper with a 24" monitor (optional)
- Enhanced quality stereo sound system
- Ambient, attractive LED illumination alongside the cabinet
- Easily accessible and visible mechanical counters
- Ergonomic features, ensuring maximum comfort
- Convenient access through an electronic key system
- Powered by **EXCITER III** platform

Peripheral Devices:

- Bill recycler
- Coin acceptor
- 2 hopper devices

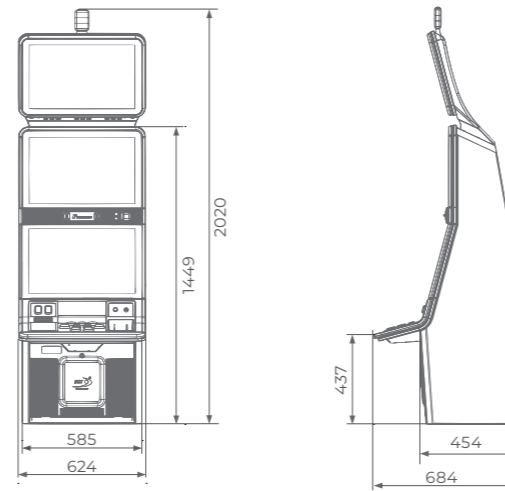

Multimedia topper (optional)

P-27/27 ST AWP

- Two high-resolution 27" widescreen monitors, the main one with an integrated touch screen for greater interactivity
- Overhead multimedia topper with a 27" monitor (optional)
- Enhanced quality stereo sound system
- Ambient, attractive LED illumination alongside the cabinet
- Easily accessible and visible mechanical counters
- Ergonomic features, ensuring maximum comfort
- Convenient access through an electronic key system
- Powered by **EXCITER III** platform

Peripheral Devices:

- Bill recycler
- Coin acceptor
- 2 hopper devices

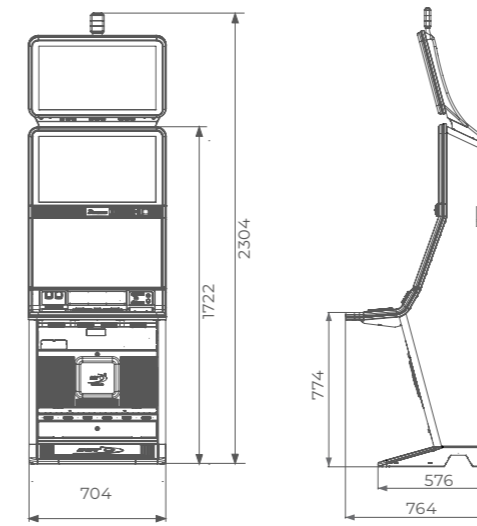

Multimedia topper (optional)



The background is a solid red color with several sets of white, parallel, curved lines. One set of lines is in the top-left corner, another set is in the bottom-right corner, and a third set is in the bottom-center, all appearing to recede into the distance.

AWP
MARKETS

Options & Features	Multi-language Autoplay Hold & Spin
Payout Options	Bills Printer
Platform	
SAS Protocol	GAT SAS 6.02
Cabinets	PH 27-27 ST AWP

● **FLAMING BONUS SELECTION** contains:

- | | |
|------------------------------|----------------------------|
| 1 5 Charming Joker Cash Heat | 6 20 Super Hot Epic Cash |
| 2 Exquisite Wealth Cash Heat | 7 Burning Hot Epic Cash |
| 3 20 Burning Hot Cash Heat | 8 Heroic Victory Epic Cash |
| 4 Shining Crown Cash Heat | 9 Eastern Carnival |
| 5 Mighty Sparta Epic Cash | 10 Amazons' Battle |

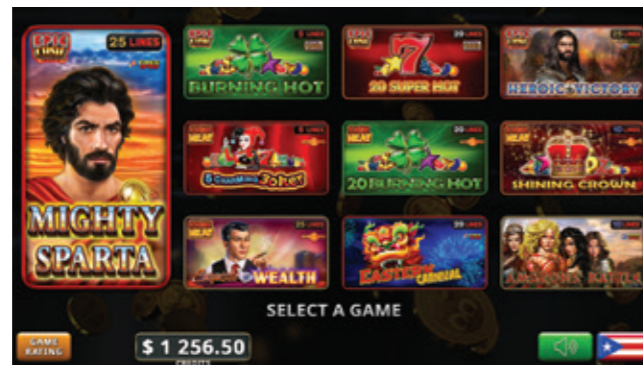

Select game screen

new

FLAMING BONUS SELECTION



Options & Features	Free Spins Feature Chance Multipliers
Payout Options	Tickets Bills Coins
Platform	EXCITER IV
SAS Protocol	SAS 6.03
Cabinets	G 27-27 ST AWP G 32-32 VIP AWP PH 27-27 AWP PH 27-27

AVAILABLE GAMES



AVAILABLE JACKPOT PANELS

GENERAL LED PANEL FLAT - SMALL

Single-sided

GENERAL LED PANEL FLAT - LARGE

Single-sided

GENERAL LED PANEL ROUNDED - SMALL

Single-sided

GENERAL LED PANEL OVAL - SMALL

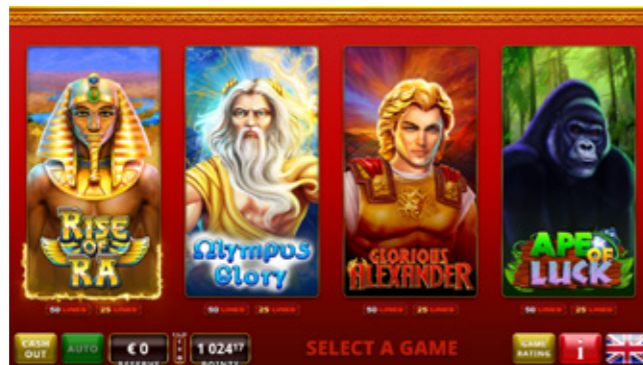

Select game screen

Premium Progressive Controller (PPC)	Gods & King Link
Jackpot	Multi-level progressive jackpot
Gaming Platform	EXCITER IV
SAS Protocol	SAS 6.03



Step into the world of Gods & Kings AWP, designed especially for the Spanish market, featuring four rewarding prize levels. With Grand and Major jackpots that are progressive and shared across all games and bets, plus dynamic Minor and Mini fixed jackpots, there's always a new way to win. Players can dive into a mystical adventure filled with divine characters and enchanting bonus games, offering a captivating experience tailored to the Spanish gaming landscape.



Options & Features	Multi-language Autoplay Gamble
Payout Options	Tickets Bills Coins Cashless transfer
Platform	EXCITER III EXCITER IV
SAS Protocol	SAS 6.02
Cabinets	G 27-27 ST AWP G 32-32 VIP AWP

AVAILABLE MULTIGAMES



Shining Crown	5 Dazzling Hot
20 Super Hot	40 Super Hot
Burning Hot	

AVAILABLE JACKPOT PANELS

GENERAL BIG LED PANEL
GENERAL BIG LED PANEL ONE-SIDED

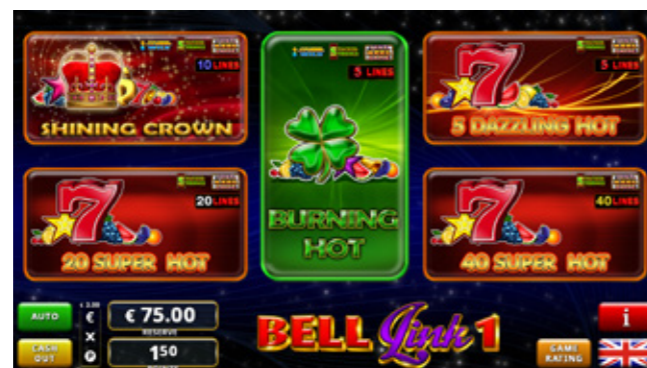

Select game screen

Premium Progressive Controller (PPC)	Bell Link
Jackpot	Multi-level progressive jackpot
Gaming Platform	EXCITER III EXCITER IV
SAS Protocol	Support of 3rd party external jackpot systems through SAS



Bell Link has 4 exciting levels, of which the Grand and Major are progressive and common for all games and bets. Minor and Mini jackpot bells are purple and blue and can be won multiple times during the Bell Link bonus; the Grand and Major levels can be attained that way too, as well as with any bet that brings a green bell or a trio of festive red bells that signal the win of the highest Grand.





BELL Link

Premium Progressive Controller (PPC)	Bell Link
Jackpot	Multi-level progressive jackpot
Gaming Platform	EXCITER III
SAS Protocol	Support of 3rd party external jackpot systems through SAS

Options & Features	Multi-language Autoplay Gamble
Payout Options	Tickets Bills Coins Cashless transfer
Platform	EXCITER III
SAS Protocol	SAS 6.02
Cabinets	G 27-27 ST AWP G 32-32 VIP AWP

AVAILABLE MULTIGAMES

BELL Link PLUS

Shining Crown	Burning Hot
20 Super Hot	40 Super Hot
Book of Realm	

AVAILABLE JACKPOT PANELS

- GENERAL BIG LED PANEL
- GENERAL BIG LED PANEL ONE-SIDED
- GENERAL LED PANEL FLAT - LARGE
- GENERAL LED PANEL FLAT - SMALL

Bell Link has 4 exciting levels, of which the Grand and Major are progressive and common for all games and bets. Minor and Mini jackpot bells are purple and blue and can be won multiple times during the Bell Link bonus; the Grand and Major levels can be attained that way too, as well as with any bet that brings a green bell or a trio of festive red bells that signal the win of the highest Grand.

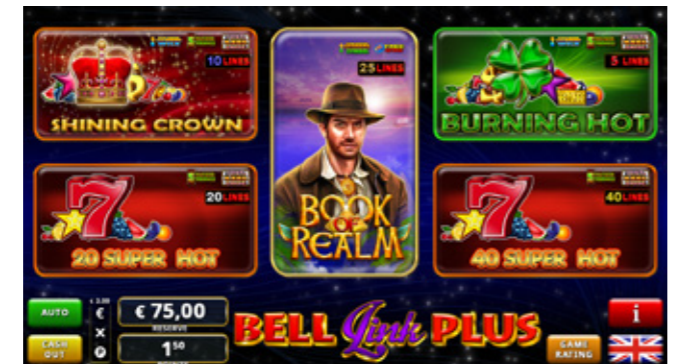

Select game screen

Options & Features	Multi-language Autoplay Gamble
Payout Options	Tickets Bills Coins Cashless transfer
Platform	
SAS Protocol	SAS 6.02
Cabinets	G 27-27 ST AWP G 32-32 VIP AWP PH 27-27 ST AWP

AVAILABLE GAMES



AVAILABLE JACKPOT PANELS

GENERAL LED PANEL OVAL Small	GENERAL LED PANEL FLAT - LARGE Single-sided
GENERAL LED PANEL ROUNDED - SMALL Single-sided	GENERAL LED PANEL FLAT - SMALL Single-sided
PANEL PHOENIX TRIPLE TV	

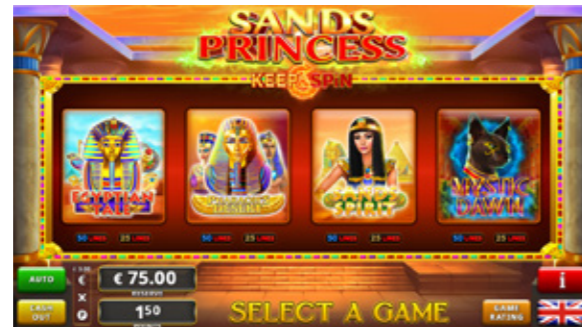

Select game screen

Premium Progressive Controller (PPC)	Sands Princess
Jackpot	Multi-level progressive jackpot
Gaming Platform	
SAS Protocol	SAS 6.02

SANDS PRINCESS



Experience the thrill of Sands Princess, where every spin holds the promise of royal riches! Dive into our Multilevel Jackpot extravaganza, featuring GRAND, MAJOR, MAXI, MINOR, and MINI levels. With GRAND & MAJOR linked progressive jackpots, MAXI stand-alone progressive jackpot, and MINOR & MINI non-progressive jackpots, there's a win for everyone.

With Sands Princess, the excitement never ends – play now and discover your path to royal rewards!





Premio Ganador is our latest multigame tailored for the Spanish market with a wide variety of titles, where each game has its theme and special features to keep players entertained for hours. Additionally, with the exciting Jackpot Cards Mystery Bonus, players can win one of four progressive prize levels at any time.

Game features include free spins, stacked symbols, re-spins, Expanding Wild, Stacked Wild, and the thrilling Keep&Spin feature, which keeps winning symbols in place for multiple spins, increasing the chances of big wins.

Discover the excitement and adventure with Premio Ganador, the multigame that is changing the game in the Spanish market!

Jackpot	Jackpot Cards Mystery Bonus with 4 progressive levels
Options & Features	Autoplay Gamble Multi-language Hold and Spin
Payout Options	Bills Coins Printer
Platform	
SAS Protocol	SAS 6.02
Cabinets	G 32-32 VIP AWP G 27-27 ST AWP PH 27-27 ST AWP

● **PREMIO GANADOR** contains:

- 1 Mighty Sparta Epic Cash
- 2 Shining Crown Cash Heat
- 3 Totems of Riches Fury Cash
- 4 Book of Magic Dazzle Cash

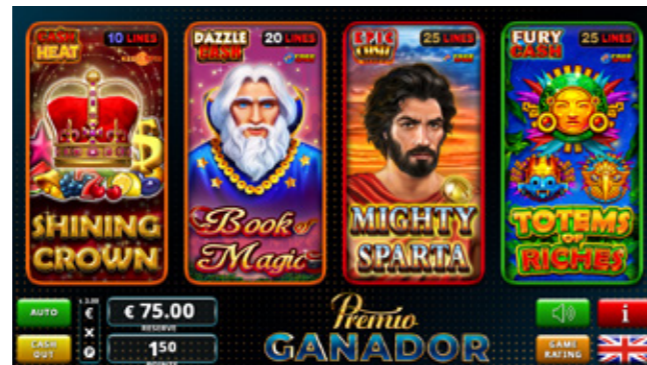

Select game screen





EGT's Red HD Collection Saloon is a new generation multigame running on the most advanced General Series cabinets - the G 32-32 VIP AWP and the G 27-27 ST AWP, which can be found in different configurations of 3- or 4- cabinets in a row formation. The available LED accessories provide a glamorous touch to the formations and increase players' excitement, making the cabinets even more attractive. The available cabinets, accessories, along with the fantastic mix of 12 games, carefully selected for the Spanish market, compose a unique solution, which will bring luster and success to any operator.

RED HD COLLECTION SALOON

Jackpot	Lady's Cards Jackpot System Tecnausa - Gran Bolsa Jackpot System
Options & Features	Autoplay Gamble Multi-language Hold and Spin
Payout Options	Tickets Bills Coins Cashless transfer
Platform	
SAS Protocol	SAS 6.02
Cabinets	G 32-32 VIP AWP G 27-27 ST AWP

● **RED COLLECTION SALOON HD contains:**

- | | |
|-----------------------|-------------------|
| 1 20 Super Hot | 7 Emperor's Dream |
| 2 40 Lucky King | 8 Extremely Hot |
| 3 40 Super Hot | 9 Leprechaun Hot |
| 4 Amazons' Battle | 10 Mighty Sparta |
| 5 81 Wins | 11 Supreme Hot |
| 6 Burning Hot 6 reels | 12 Shining Crown |

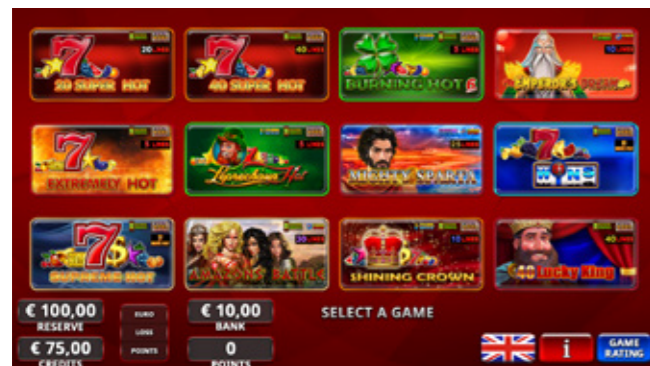

Select game screen



Keyboard screen



GREEN HD COLLECTION SALOON

Designed to be highly attractive on the casino floor and compelling to players with every game available are two of the main characteristics of EGT's slot cabinets, but they are also made to be easily utilized by operators everywhere. The installation process is effortless, and so is configuring and arranging the machines in any way required by the operator and his establishment.

Jackpot	Lady's Cards Jackpot System Tecnausa - Gran Bolsa Jackpot System
Options & Features	Hold and Spin Cluster Wins Autoplay Gamble Multi-language
Payout Options	Bills Coins Cashless transfer
Platform	
SAS Protocol	SAS 6.02
Cabinets	P-24/24 UP AWP P-27-27 ST AWP

GREEN COLLECTION SALOON HD contains:

- | | |
|------------------|--------------------|
| 1 20 Super Hot | 7 Great 27 |
| 2 27 Wins | 8 Irish Charm |
| 3 40 Burning Hot | 9 Mighty Sparta |
| 4 40 Super Hot | 10 KENO Galaxy |
| 5 Burning Hot | 11 Versailles Gold |
| 6 El Amigo | 12 Lucky Food |

P-27/27 ST AWP Configurations:

- 2 P-27/27 ST AWP | WxHxD 1448x2260x740
- 3 P-27/27 ST AWP | WxHxD 2154x2260x740
- 4 P-27/27 ST AWP | WxHxD 2860x2260x740

Dimensions do not include jackpot panel

P-24/24 UP AWP Configurations:

- 2 P-24/24 UP AWP | WxHxD 1535 x 2410 x 620
- 3 P-24/24 UP AWP | WxHxD 2410 x 2410 x 620
- 4 P-24/24 UP AWP | WxHxD 3285 x 2410 x 620

Dimensions do not include jackpot panel

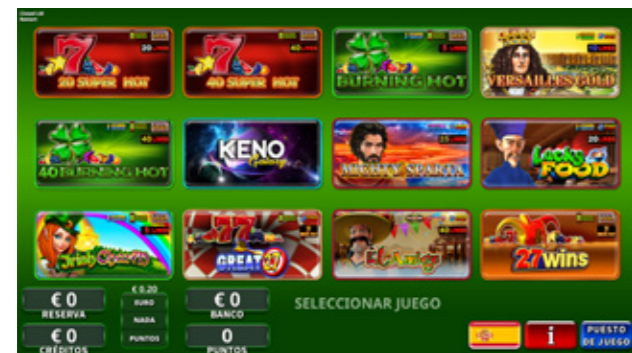

Select game screen



Screensaver screen



ORANGE COLLECTION SALOON



Customization and configurability are key advantages of our cabinet series. Grouping, arranging, and positioning them is made highly flexible in order to fulfill every establishment's needs and necessities. Players are enamored with the slick design and captivated by the engaging and entertaining gaming experience.

Jackpot	Lady's Cards Jackpot System Tecnausa - Gran Bolsa Jackpot System
Options & Features	Autoplay Gamble Multi-language
Payout Options	Bills Coins Cashless transfer
Platform	EXCITER III
SAS Protocol	SAS 6.02
Cabinets	P-24/24 UP AWP P-27/27 ST AWP

ORANGE COLLECTION SALOON contains:

- | | |
|-------------------|---------------------------|
| 1 20 Super Hot | 13 Dice & Roll |
| 2 40 Super Hot | 14 20 Hot Blast |
| 3 Burning Hot | 15 Rise of Ra |
| 4 Versailles Gold | 16 Flaming Hot |
| 5 Zodiac Wheel | 17 Fortune Spells |
| 6 Amazons' Battle | 18 Great Empire |
| 7 Lucky Hot | 19 Secrets of Alchemy |
| 8 Fruits Kingdom | 20 Retro Cabaret |
| 9 Olympus Glory | 21 Extra Stars |
| 10 40 Mega Clover | 22 The Story of Alexander |
| 11 Shining Crown | 23 Almighty Ramses II |
| 12 5 Dazzling Hot | 24 Spanish Passion |

P-27/27 ST AWP Configurations:

- 2 P-27/27 ST AWP | WxHxD 1448x2260x740
 - 3 P-27/27 ST AWP | WxHxD 2154x2260x740
 - 4 P-27/27 ST AWP | WxHxD 2860x2260x740
- Dimensions do not include jackpot panel

P-24/24 UP AWP Configurations:

- 2 P-24/24 UP AWP | WxHxD 1535 x 2410 x 620
 - 3 P-24/24 UP AWP | WxHxD 2410 x 2410 x 620
 - 4 P-24/24 UP AWP | WxHxD 3285 x 2410 x 620
- Dimensions do not include jackpot panel



Select game screen 1



Select game screen 2



new

BONUS PRIZE COLLECTION



Options & Features	Cash Heat Epic Cash Keep & Spin Prize Multipliers Thriller Games Wild feature Coffee Break Multi-language
Payout Options	Bills Coins Cashless transfer
Platform	
VAN Protocol	VAN 18 F2
Cabinets	G 27-27 ST AWP G 32-32 VIP AWP PH 27-27 AWP

● **BONUS PRIZE COLLECTION** contains:

- 1 5 Charming Joker Cash Heat
- 2 20 Burning Hot Cash Heat
- 3 Shining Crown Cash Heat
- 4 Exquisite Wealth Cash Heat
- 5 Mighty Sparta Epic Cash
- 6 Burning Hot Epic Cash
- 7 20 Super Hot Epic Cash
- 8 Heroic Victory Epic Cash
- 9 Eastern Carnival
- 10 Amazons' Battle



Select game screen



Screensaver screen

PURPLE HD COLLECTION



Options & Features	Bonus Prize Feature Prize Multipliers Thriller Games Wild Feature Coffee Break Multi-language
Payout Options	Bills Coins Cashless transfer
Platform	EXCITER III EXCITER IV
VAN Protocol	VAN 18 F2
Cabinets	G 27-27 ST AWP (video-keyboard) G 32-32 VIP AWP (video-keyboard) P-24/24 UP AWP P-27-27 ST AWP

● **PURPLE COLLECTION HD contains:**

- 1 Mighty Sparta
- 2 20 Super Hot
- 3 10 Joker Reels
- 4 Burning Hot
- 5 Almighty Ramses II
- 6 Luxury Hot
- 7 Amazons' Battle
- 8 Rise of Ra
- 9 5 Charming Joker
- 10 10 Joker Burst

G 27-27 ST AWP Configurations:

- 3 G 27-27 ST AWP | WxHxD 2468x2237x749
- 4 G 27-27 ST AWP | WxHxD 3362x2237x749

P-27/27 ST AWP Configurations:

- 2 P-27/27 ST AWP | WxHxD 1448x2260x740
- 3 P-27/27 ST AWP | WxHxD 2154x2260x740
- 4 P-27/27 ST AWP | WxHxD 2860x2260x740

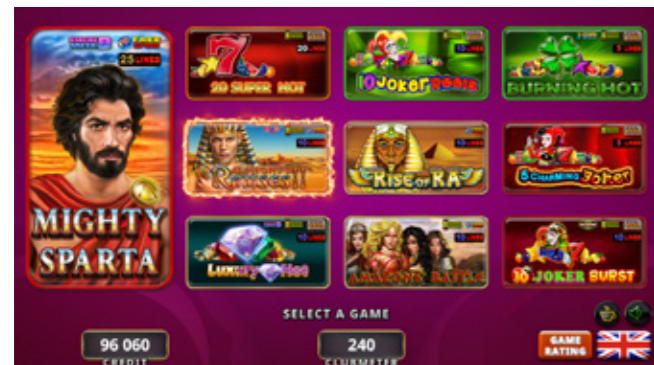

Select game screen



Screensaver screen



ORANGE COLLECTION



Options & Features	Multi-language Coffee Break feature Thriller Games feature
Payout Options	Bills Coins Cashless transfer
Platform	EXCITER III
VAN Protocol	VAN 18 F2
Cabinets	P-24/24 UP P-27-27 ST AWP

● **ORANGE COLLECTION contains:**

- 1 Burning Hot
- 2 20 Super Hot
- 3 Rise of Ra
- 4 10 Joker Reels
- 5 Burning Hot 6 reels
- 6 81 Wins
- 7 5 Charming Joker
- 8 Almighty Ramses II
- 9 Extremely Hot
- 10 Vampire Night
- 11 27 Wins
- 12 Extra Stars

P-24/24 UP AWP Configurations:

- 2 P-24/24 UP AWP | WxHxD 1535 x 2410 x 620
- 3 P-24/24 UP AWP | WxHxD 2410 x 2410 x 620
- 4 P-24/24 UP AWP | WxHxD 3285 x 2410 x 620

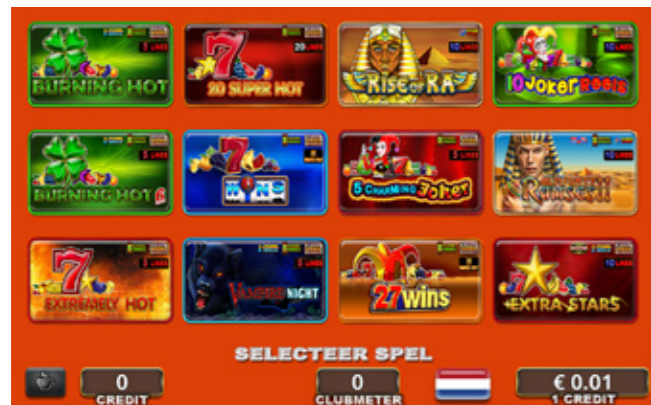

Select game screen 1



Screensaver screen

Selected Premier cabinets house our new selection specially curated for the South African market. Players can indulge in 12 titles on the classic P 24-24 UP, enjoying a visually stunning and enthralling gaming experience, a high-quality sound system and even an in-game spin wheel specially designed for South Africa, called the Thriller Game.

Options & Features	Easy Games Easy Spin Respin Thriller Games
Payout Options	Bills Cashless transfer
Platform	
SAS Protocol	SAS 6.02
Cabinets	P-24/24 UP

● **BIG 5 COLLECTION LION** contains:

- 1 5 Charming Joker
- 2 5 Dazzling Hot
- 3 Almighty Ramses II
- 4 Amazon's Battle
- 5 Burning Hot
- 6 Coral Island
- 7 Dice & Roll
- 8 Emperor's Dream
- 9 Extra Stars
- 10 Flaming Hot Extreme
- 11 Olympus Glory
- 12 Rise of Ra

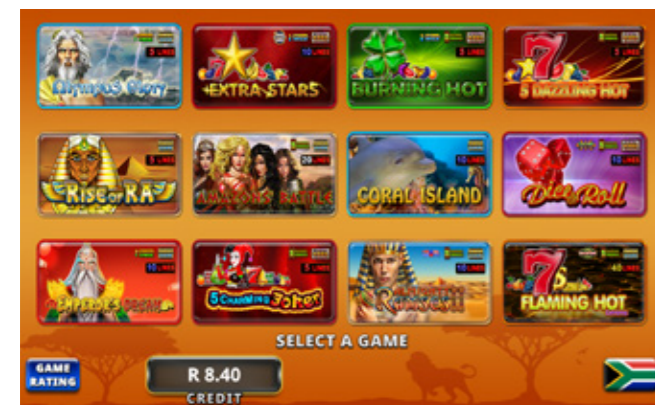

Select game screen 1



Thriller game screen

BIG 5 COLLECTION LION



A vast array of Premier and Vega Vision slant top and upright cabinets are available, famous for their high performance and elegant design. Their ergonomic features, crystal clear sound, powerful platform, and rich gaming library will team up for the top gaming satisfaction of your patrons.

Options & Features	Autoplay Gamble English language Extra Game
Payout Options	Bills Coins
Platform	
SAS Protocol	SAS 6.02
Cabinets	P-24/24 UP P-27/27 ST Slim P-24/24 UP Slim Vega Vision Vega Vision +

● **AWP FRUITS COLLECTION** contains:

- 1 20 Super Hot
- 2 40 Super Hot
- 3 100 Super Hot
- 4 100 Lucky Hat
- 5 Burning Hot
- 6 20 Burning Hot
- 7 40 Burning Hot
- 8 100 Burning Hot
- 9 40 Mega Clover
- 10 50 Mega Clover
- 11 Flaming Hot
- 12 100 Flaming Hot
- 13 Extra Stars
- 14 20 Extra Stars
- 15 40 Extra Stars
- 16 40 Ultra Respin
- 17 5 Dazzling Hot
- 18 20 Dazzling Hot
- 19 20 Hot Blast
- 20 50 Hot Blast
- 21 30 Spicy Fruits
- 22 50 Spicy Fruits
- 23 20 Joker Reels
- 24 40 Joker Reels
- 25 Shining Crown
- 26 40 Shining Crown
- 27 5 Burning Heart
- 28 10 Burning Heart
- 29 Dice & Roll
- 30 more Dice & Roll
- 31 Lucky & Wild
- 32 more Lucky & Wild
- 33 Hot & Cash
- 34 40 Hot & Cash
- 35 20 Charming Joker
- 36 40 Lucky King
- 37 5 Juggle Fruits
- 38 Caramel Hot
- 39 Super 20
- 40 Dice High
- 41 Lucky Hot
- 42 Extremely Hot
- 43 Ultimate Hot
- 44 5 Great Star
- 45 Supreme Hot
- 46 Great 27
- 47 27 Wins
- 48 81 Wins

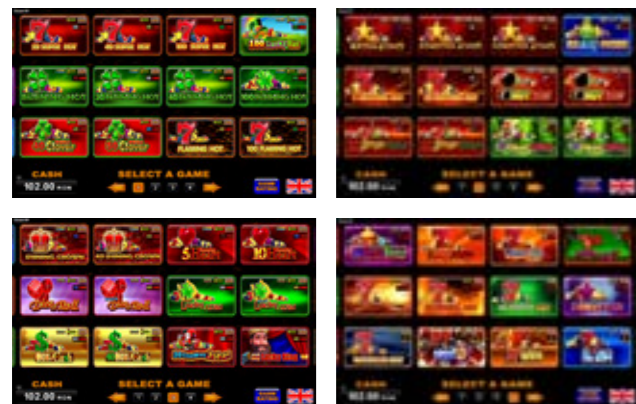

Select game screens

AWP FRUITS COLLECTION



The background is a solid red color with several sets of white, parallel, curved lines that create a sense of depth and movement. One set of lines is in the top-left corner, another set is in the bottom-right corner, and a third set is in the bottom-center, all appearing to recede into the distance.

SPIDER
Casino Management System

Spider's key features

ACCOUNTING MODULE

Upgrade your day-to-day casino management activities to the next level and have all the needed detailed reports at hand. Get a clear view on any aspect that will make your business even more successful and be in touch 24/7 with the gaming machines on your casino floor.

CAGE MODULE

Control all cash operations in your casino, have a detailed transaction history and real-time balance level.

TITO MODULE

Get better control and increase the security of the casino cash flow. Combine them with "promotional tickets" as an additional bonus tool.

VAULT MODULE

Process unlimited cage and table sessions. The real-time money and chips inventory will give you a clear view to all the funds in your casino.

JACKPOT MODULE

Increase your players' excitement by adding a local, or wide-area progressive, or mystery jackpot. Customize your system templates to suit your needs and taste.

SECURITY AND ALARM MODULE

Configure different user access levels and receive real-time notifications from your Spider system. Be sure that your casino will keep on running smoothly as planned.

PLAYER TRACKING

Identify the different types of players in your casino, so you could tailor your approach to everyone. Segment your players using multiple criteria.

BONUSING MODULE

Motivate the players to return to your casino again and again. The automated campaigns and targeted promotions will help you increase the revenue and dominate over the competitors.

CASHLESS MODULE

Provide the players with the comfort to use their loyalty cards as an eWallet. Decrease the costs compared to TITO and have a more secure way to transfer money and redeem bonuses.

TABLES MANAGEMENT MODULE

Get full control over the tables section on your casino floor. Include your tables into all accounting, player tracking, and bonusing activities.

RAFFLES MODULE

Customize your raffle campaigns with different ticket accumulation and participation criteria while having unlimited counts to suit your personal needs.

LUCKY BOX AND LUCKY CARDS BONUS FEATURE

Choose the bonus feature based and personalize the prizes, trigger, and participation criteria to captivate players.

CASHLESS WAGER BONUS

You configure the wager options by giving the player opportunity to track it and have a separate one in their eWallet.

WIN THE SPIN BONUS FEATURE

Provides operators with the opportunity to set up a range of rewards, and after the fulfillment of different criteria defined by operators, players get the chance to play roulette. What they earn from it generates a bonus that can be cashed out.

SPIDER LOYALTY CLUB MOBILE APP

Use the loyalty club app to have easy access to redeem bonuses, fund transfers, and get info about players, raffle tickets, and jackpots all in one place.

TOURNAMENTS MODULE

Allows operators to offer competition to their customers with flexible scoring logic.

Why is it worth your investment?

- Fast to install and easy to connect
- User-friendly interface
- Requires a simple IT infrastructure
- Provides remote management and control over your casino
- Fully customizable to fit various operators' requirements
- 24/7 support from a highly professional team



ACCOUNTING MODULE

- Daily reports
- Jurisdictional reports
- Real-time meters view
- Custom reports builder

CAGE MODULE

- Issue and redeem tickets
- Foreign currency exchange with variable rates, adjusted by the operator
- Processing handpays, jackpots and all the income and outcome funds in the casino

TITO MODULE

- Cashable and promotional tickets
- Reduced operation costs
- Detailed ticket states and accounting information
- Decreases handpays to a minimum

VAULT MODULE

- Real-time cash balance
- Multiple Cage sessions
- Redemption machines support
- Bill stacker clearance



SECURITY AND ALARM MODULE

- Real-time events reporting
- Real-time alarms
- Detailed separation of user access



JACKPOT MODULE

- An ultimate jackpot solution
- Supports multigame and multi-denomination progressive jackpots
- Supports standard and time-based mystery jackpots
- Enables you to set up your jackpot schedule and client participation
- Includes a Multimedia Control Center with:
 - Full HD graphic and video panels
 - Interactive jackpot triggering frames
 - Advertising videos



PLAYER TRACKING MODULE

- Real-time player info
- Multi-site accounts
- Detailed client history
- Statistics for carded or non-carded play
- Loyalty and incentive programs for the players



BONUSING MODULE

- Powerful bonusing tools
- Different types of bonus points, cashable or promotional credit rewards
- New level of interactive instant rewarding
- Automated marketing promotions



TABLES MANAGEMENT MODULE

- Roulette and card tables support
- Table games players tracking
- Table games players bonusing
- Chip balance in real-time



CASHLESS MODULE

- Single and multisite support
- Cashable and promotional credits support
- Cost-effective compared to TITO
- PIN protected accounts



CASHLESS WAGER BONUS

- Separate Wager balance in player's eWallet
- Wager progress which can be seen by the player on PT Display
- Wager amount configurable by the operator

RAFFLES MODULE

- Unlimited count of various Raffle campaigns based on the operator's needs
- Tickets accumulation based on:
 - Bet
 - Loss balance
 - Win balance of the players
- Participation based on:
 - Time
 - Player level
 - Gender
 - Slots / Tables
 - Carded and Non-carded play
- Progressive jackpots based on the missing players' prizes
- Draws based on printed or electronic tickets

LUCKY BOX AND LUCKY CARDS BONUS FEATURE

- The bonus feature is automated campaign based on the real-time play of the players as they have the chance to choose either a box or card with a specific reward
- Trigger criteria based on:
 - Real-time Bet
 - Loss balance
 - Win balance
- Participation based on:
 - Time
 - Player level
 - Gender
 - Slots / Tables
- Multi-level support with different trigger amounts and prizes
- Prizes with "Double up" and "Try Again" option
- Multiple prize type such as:
 - Cashable credits
 - Promo credits
 - Items
- Only for Carded play

WIN THE SPIN BONUS FEATURE

- Provides operators with the opportunity to set up a range of rewards, and after the fulfillment of different criteria defined by operators, players get the chance to play roulette. What they earn from it generates a bonus that can be cashed out.
- Operators have the freedom to control and define almost everything: from stakes to prizes and configurations, which can be unlimited.



TOURNAMENTS MODULE

- Allows operators to offer competition to their customers with flexible scoring logic
- Multiple participation criteria based on:
 - Bet
 - Win
 - Bet / Win accumulation
 - Win / Bet accumulation
 - Win / Bet Max ratio
- Real time updated leaderboards
- One time / hourly / daily or monthly tournaments
- Meet player needs with customized prizes



SPIDER LOYALTY CLUB MOBILE APP

Use the loyalty club app to have easy access to redeem bonuses, fund transfers, and get info about players, raffle tickets, and jackpots all in one place.

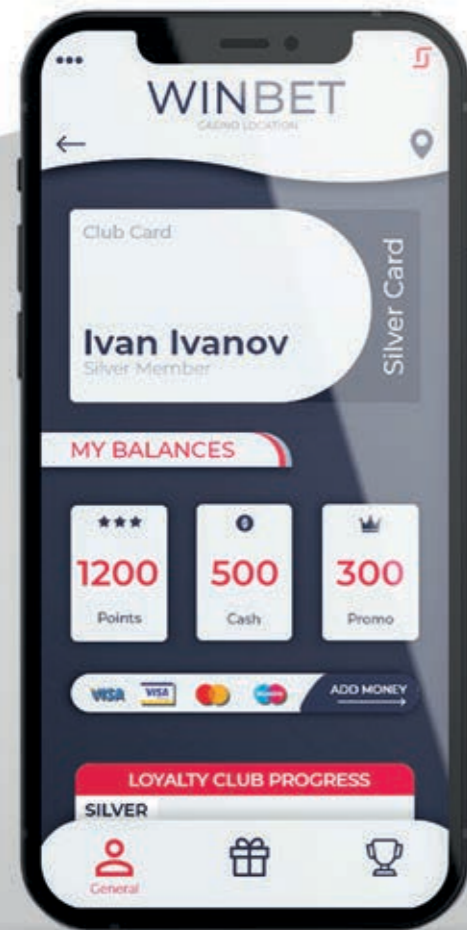

- On-site players device verification
- Detailed player's info for:
 - Accumulated points
 - Cash and promo credits
 - Player level and progress
- Slot machine login without card
- Transfer funds from eWallet directly to gaming machine
- Redeem bonuses directly to gaming machine
- Raffles electronic tickets info
- In-app virtual POS to transfer money from player bank account to account in the casino
- Real-time Mystery and Progressive jackpots info
- Push notifications for new bonuses

SPIDER KIOSK

The Spider Kiosk significantly improves customer experience and expands revenues. Its other standout features include a lottery ticket printing option, viewing players' bonuses and viewing players' account balance – cash credits, promo credits, and points.

- Eye-catching design
- 27" full HD touchscreen monitor
- Takes little space and is easy to install at every part of the casino floor
- Fast printing ticket and raffle coupon printer
- Supports magnetic or RFID card reader



The background is a solid red color. It features several sets of white, parallel lines that curve and flow across the page. One set of lines is in the top-left corner, another set is in the bottom-right corner, and a large set of lines curves across the bottom of the page. The word 'CONTACTS' is centered in the white space between the bottom-left and bottom-right line groups.

CONTACTS

EGT INTERNATIONAL

Sales and Distribution Team



Vladimir Dokov
Chief Executive Officer
+359 2 890 24 00
vladimir.dokov@egt.com



Emilia Tomachinska
Managing Director – E-Systems GmbH
Germany, Switzerland, The Baltics
+49 172 547 3558
emilia@e-systemsgmbh.de

E-Systems GmbH
EGT Distributor
Germany, Switzerland, The Baltics
Jathostr. 8, 30916 Isernhagen, Hannover, Germany
+49 511 450 6390 | Fax: +49 511 450 639 52
emilia@e-systemsgmbh.de



Taco de Leeuw
Sales Manager -
RR Gaming International BV
The Netherlands
+31 10 422 0489
taco@roulettemachines.nl

RR Gaming International BV
EGT Distributor
The Netherlands
Schuttevaerweg 9A, 3044 BA Rotterdam,
The Netherlands
+31 10 422 0489
taco@roulettemachines.nl | info@roulettemachines.nl



Nadia Popova
Chief Revenue Officer
VP Sales & Marketing
+507 62 416 599
+359 882 93 66 35
+507 386 2719
nadia.popova@egt.com

Euro Games Technology Ltd.
Panama
PH Pacific Center,
Torre A, piso 31,
Panama City, Panama
Mobile: +507 62 416 599 | nadia.popova@egt.com



Alejandro Mosquera
Director – EGT Spain
Spain
+34 653 519 529
alejandro.mosquera@egt.com

Euro Games Technology Ltd.
Spain
Parque Empresarial Vía Norte,
Calle Quintanavides, 13-23,
Módulo E, planta 3, Madrid, Spain
+34 653 519 529 | alejandro.mosquera@egt.com



Parvan Parvanov
Rental Director
+359 2 890 24 44
parvan.parvanov@egt.com

Euro Games Technology Ltd.
Bulgaria
RichHill Business Center, Block A,
6 Panorama Sofia St., Sofia Park,
1766 Sofia, Bulgaria
+359 2 890 24 00 | sales@egt.com



Zornitsa Boncheva
Regional Manager - Italy
Italy
+359 878 547 061
zornitsa.boncheva@egt.com

Euro Games Technology Ltd.
Italy
Italy
+359 878 547 061
zornitsa.boncheva@egt.com



Biserka Draganova
Sales Manager – The Balkans
and Egypt
+359 894 69 67 64
biserka.draganova@egt.com

Euro Games Technology Ltd.
Bulgaria
RichHill Business Center, Block A,
6 Panorama Sofia St., Sofia Park,
1766 Sofia, Bulgaria
+359 2 890 24 00 | sales@egt.com



Stefan Dimov
Director - EGT Ireland
Ireland, Northern Ireland & Portugal
+353 879 520 387
+359 878 540 258
stefan.dimov@egt.com

Euro Games Technology Ltd.
Ireland, Northern Ireland & Portugal
16 Francis St., Dundalk,
Co Louth A91 CX46, Ireland



Csaba Pardi

Director – Demar KFT

Hungary, Slovakia, Sweden

+36 30 406 62 65
csaba.pardi@egt.com

Demar KFT

EGT Distributor

Hungary, Slovakia, Sweden

4 Vas Gereben Str., 1195 Budapest, Hungary

+36 1 348 02 21 | Fax: +36 1 348 02 22
csaba.pardi@egt.com



Aleksandar Kliska

General Director – EGT Group d.o.o.

Serbia, Bosnia and Herzegovina -
Republika Srpska

+381 64 56 86 386
aleksandar.kliska@egt.com

EGT Group d.o.o.

Serbia

Zemunska 47,
11070 Novi Beograd-Beograd,
Serbia

+381 64 56 86 386
sales-rs@egt.com
www.egt-bg.rs

Bosnia and Herzegovina
-Republika Srpska

Cara Dušana 218, Banja Luka
Bosnia and Herzegovina
-Republika Srpska

Mobile: + 381 64 56 86 386
sales-ba@egt.com
service.ba@egt.com



Francois Bourlier

Director - Mascot SFM

France

+33 6 03 87 29 91

Mascot SFM

EGT Distributor

France

16 rue Christophe Colomb
94730 Sucy-en-Brie, Paris, France

+33 1 56 73 20 33



Dobriyan Spirov

Regional Manager –
EGT North Macedonia

North Macedonia

+389 78 306 920
dobrian.spirov@egt.com

Euro Games Technology Ltd.

North Macedonia

1000 Skopje, North Macedonia
Bul. Boris Trajkovski 214A, Kisela Voda

+389 78 306 920 | +359 898 41 54 53
dobrian.spirov@egt.com



Marieta Peleva

Sales Manager - EGT Poland

Poland, Belgium, Czech Republic

+359 878 568 206
marieta.peleva@egt.com

Euro Games Technology Ltd.

Poland

Warsaw, Poland

+359 878 568 206
marieta.peleva@egt.com



Heinrich Sasnovskiy

Director – EGT Belarus Ltd.

Belarus

+37529 680 30 30
heinrich.sasnovskiy@egt.com

EGT Belarus Ltd.

Belarus

12, Lipkovsky lane, room 424
220138 Minsk, Belarus

+37529 680 30 30 | +37529 800 09 45 | +37517 320 67 87
heinrich.sasnovskiy@egt.com
tzvetomil.nikolov@egt.com



Razvan Andronic

Sales Director – EGT Romania

Romania

+40 (758) 114 227
razvan.andronic@egt-bg.com

Euro Games Technology Ltd.

Romania

1-3 Matei Dumitru St., 020321 Bucharest,
District 2, Romania

+40 (757) 097 813 | +0374 835 760
office@egt-bg.ro | www.egt-bg.ro

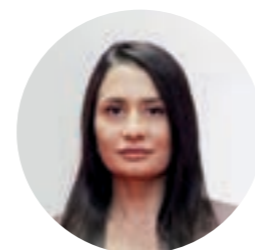

Tamar Gigolashvili

Head of Sales - EGT Georgia

Georgia, Kazakhstan, Armenia, Ukraine

tamar.gigolashvili@egt.com

Euro Games Technology Ltd.

Georgia, Kazakhstan, Armenia, Ukraine

N15 Giorgi Saakadze II Ln., 0160 Tbilisi, Georgia

+995 32 24 07 365
sales.georgia@egt.com
tech-service-georgia@egt.com



Maja Skelin

Sales Manager – Mutabor d.o.o.

Croatia, Montenegro, Slovenia

+385 91 366 66 96
maja.skelin@egt.com

Mutabor d.o.o.

EGT Distributor

Croatia, Montenegro, Slovenia

Savska cesta 153,
10 000 Zagreb, Croatia

Mobile: +385 91 366 66 96 | maja.skelin@egt.com

**Alice Tang**

Managing Director –
Winning Asia Technology Ltd.
Macau

+85 32 871 88 48
alice@winningasia.com

Winning Asia Technology

EGT Distributor

Macau

Av. do Dr. R. Rodrigues, No. 600E,
Edif. "First Int. Comm. Centre", P906 Macau, S.A.R
Phone: +853 287 18 848 | enquiry@winningasia.com

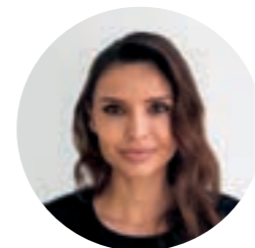
**Yana Mihaleva**

Director –
Central America and the Caribbean
Central America and the Caribbean

+507 63 07 05 27
+359 882 93 63 09
yana.mihaleva@egt.com

Euro Games Technology Ltd.

Panama

PH Bicsa, Office 35-03,
Calle Aquilino de La Guardia,
Panama City, Panama

+507 63 07 05 27 | yana.mihaleva@egt.com

**Chuah Eng Meng**

Managing Director –
Channel Paradise Sdn. Bhd
Malaysia

+604 263 99 11
info@mychannelparadise.com
info@cp-gaming.com

Channel Paradise Sdn. Bhd

EGT Distributor

Malaysia

27, Green Hall, 10200 Georgetown,
Penang, Malaysia
+604 263 98 88
info@mychannelparadise.com | info@cp-gaming.com

**Silviya Marinova**

Director –
Euro Games Colombia S.A.S.
Colombia, Chile, Uruguay

+57 3222 690 841
+ 359 87 706 81 54
silviya.marinova@egt.com

Euro Games Colombia S.A.S.

Colombia

15-27 93rd Street, office 705,
Edificio AVANTE 93, Bogota, Colombia

+57 3222 690841 | +359 87 706 81 54
silviya.marinova@egt.com

**Mark Larson**

Chief Executive Officer -
Dynamic Gaming Solutions
USA, Oklahoma

+405 417 6104
mark@dynamicgamingsolutions.com

Dynamic Gaming Solutions

EGT Distributor

USA, Oklahoma

4320 South Portland Avenue
Oklahoma City, OK 73119
+405 417 6104
mark@dynamicgamingsolutions.com

**Katerina Podymaska**

Director – EGT Argentina S.A.
Argentina

+507 67 03 62 47
christian.graffigna@egt.com

EGT Argentina S.A.

Argentina

Lavalle 3538, Capital Federal Almagro (1190) CABA,
Buenos Aires, Argentina

+507 67 03 62 47
christian.graffigna@egt.com

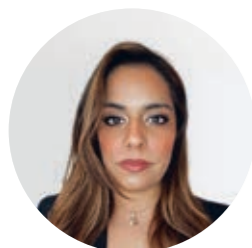
**Pamela Gutierrez**

Sales Director - Mexico
Mexico

+52 55 54590172
pamela.gutierrez@egt.com

Euro Games Technology Ltd.

Mexico

Edificio Zurich Calle Lago Zurich N° 245 Piso 16
Int. 1603 Colonia Ampliación Granada Alc. Miguel
Hidalgo C.P. 11520

+52 55 54590172 | pamela.gutierrez@egt.com

**Mario Trayanski**

Director – EGT Peru
Peru

+51 920 106 820
mario.trayanski@egt.com

Euro Games Technology Ltd.

Peru

Torre ABACO, Av. Andrés Reyes 420,
Piso 10, 15046 San Isidro, Lima, Peru

+51 920 106 820
mario.trayanski@egt.com

**Lilia Georgieva**

Director – EGT Tanzania
Tanzania, Uganda, Rwanda,
Ghana, Zambia, Cameroon, Angola

+255 742 70 52 07
lilia.georgieva@egt.com

Euro Games Technology Ltd.

Tanzania, Uganda, Rwanda, Ghana,
Zambia, Cameroon, Angola

G-06 office, ground floor, Renaissance Plaza,
1391 Haile Selassie Road, Masaki,
Dar es Salaam, Tanzania

+255 742 70 52 07 | lilia.georgieva@egt.com

**Steve Diversi**

Managing Director –
Custom Gaming Solutions (Pty) Ltd.
Republic of South Africa

Mobile: +27 82 565 1238
steve@customgaming.co.za

Custom Gaming Solutions (Pty) Ltd.

EGT Distributor

Republic of South Africa

P.O. box 15664, 8018 Vlaeberg,
South Africa

+27 860 664 443 | +27 82 565 1238
Fax: +27 86 555 4677 | info@customgaming.co.za

**Zsuzsanna Zeibig**

Sales Manager - Kenya
Kenya

+254745074553
+34603322820
zuzi.zeibig@egt.com

Euro Games Technology Ltd.

Kenya

Nairobi, Kenya

+254745074553 | +34603322820
zuzi.zeibig@egt.com